

UNIVERSITY OF CAMBRIDGE INTERNATIONAL EXAMINATIONS

International General Certificate of Secondary Education

MARK SCHEME for the November 2005 question paper

0445 DESIGN AND TECHNOLOGY

0445/04

Paper 4 maximum raw mark 60

This mark scheme is published as an aid to teachers and students, to indicate the requirements of the examination. It shows the basis on which Examiners were initially instructed to award marks. It does not indicate the details of the discussions that took place at an Examiners' meeting before marking began. Any substantial changes to the mark scheme that arose from these discussions will be recorded in the published *Report on the Examination*.

All Examiners are instructed that alternative correct answers and unexpected approaches in candidates' scripts must be given marks that fairly reflect the relevant knowledge and skills demonstrated.

Mark schemes must be read in conjunction with the question papers and the *Report on the Examination*.

The minimum marks in these components needed for various grades were previously published with these mark schemes, but are now instead included in the Report on the Examination for this session.

- CIE will not enter into discussion or correspondence in connection with these mark schemes.

CIE is publishing the mark schemes for the November 2005 question papers for most IGCSE and GCE Advanced Level and Advanced Subsidiary Level syllabuses and some Ordinary Level syllabuses.



1 (a) (i)

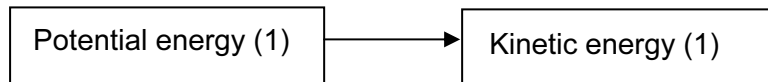

[2]

(ii) Through friction (1) and no guidance for the ball (1)

[2]

(iii) Channel the ball along grooves

[2]

(iv) Suitable design to include:

- Holding method,
- Calibration,
- Force measurement,
- Quality of response.

[4]

(b) (i)

[3]

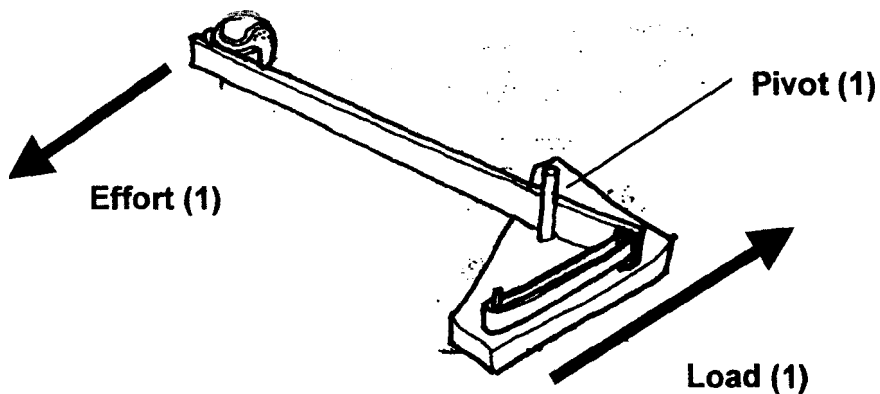

(ii) Force (1) x Distance from fulcrum (1)

[2]

(iii) Could use Mecanno type kit; could use cardboard and drawing pins

[2]

(c) (i) Suitable sketching to show a brace or gusset plate (2)
Quality of response (1)

[3]

(ii) Suitable sketches that clearly show an understanding of the use of DTI

[3]

(iii) Strain gauge

[1]

(d) (i)

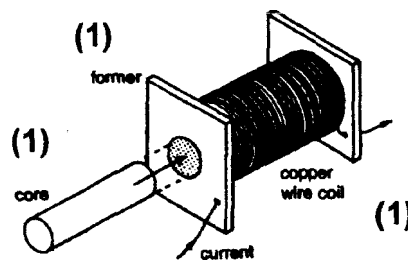

[3]

Page 2	Mark Scheme	Syllabus	Paper
	IGCSE – November 2005	0445	04

(ii) Light Dependant Resistor (LDR) [1]

(iii) To prevent back emf (1) damage (1) to the transistor [2]

2 (a) (i)

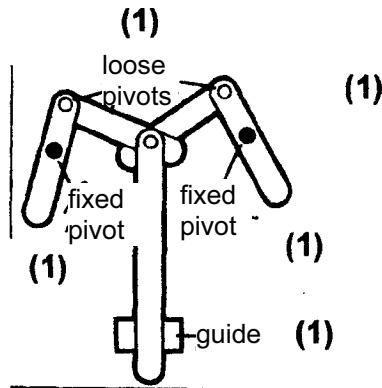

[5]

(ii) Linear (1); Rotation (1); Oscillation (1) [3]

(iii) Mecanno; Fischer Technik; Card and paper fasteners [2]

(b) (i) Cam [1]

(ii) A row of cam (1) with each one having its centre set at different positions on the shaft (1) triggers the switches at different time for on rotation of the shaft (1) [3]

(iii) Pulley wheel [1]

(iv) Worm gear [1]

(v) Quiet; no slip [2]

(c) (i) (1)

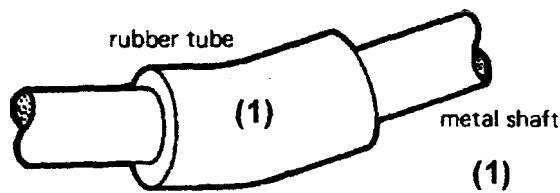

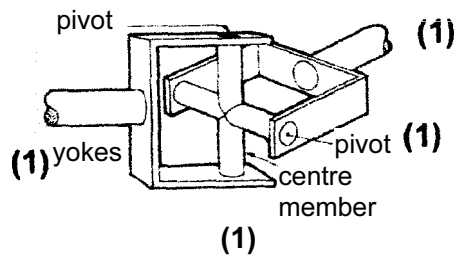

[3]

(ii)

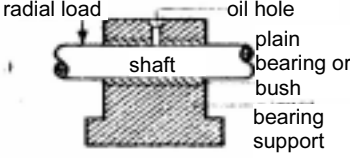

[4]

(iii)

Bearing	Diagram	Application
Plain Journal Bearing		Low speed shaft support
Ball bearing (1)		Washing machine drum
Roller bearing		Heavy radial loads at low speeds

[4]

(iv) Reduce friction; reduce wear; reduce heat

[1]

3 Structures can be classified in to two main types

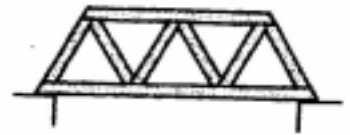
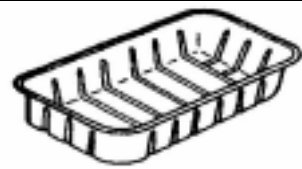
Type of structure	Example	Application
Framework		Bridge [1]
Shell [1]		Car body [1]

(b) (i) The effect of impact (1) can cause a structure to fail (1). It increases the moment (1) of the applied force. [3]

(ii) Benefit: Quick and easy to build up a structure [2]
 Drawback: Tend to buckle easily [2]

(iii)

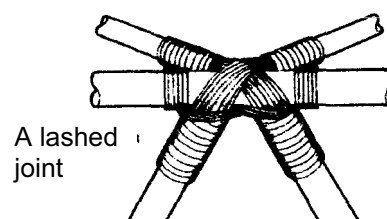

(c) (i)

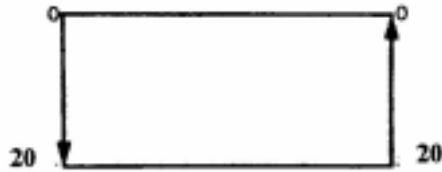

[3]

(ii)

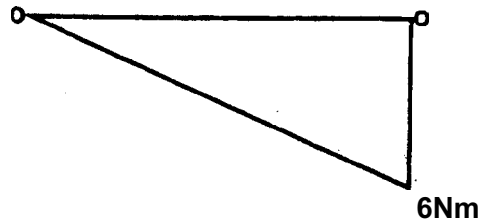

[3]

(d) (i) Moments @ R1
 $10 \times 0.75 = 3 \times R_2$ (1)
 $7.5/3 = R_2$ (1) = 2.5 N (1)
 For equilibrium $R_1 + R_2 = 10$ N
 thus $R_1 = 10$ N - 2.5 N = 7.5 N (1)

[4]

(ii)

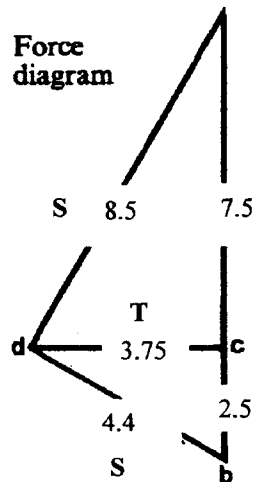

[6]

4 (a) (i)

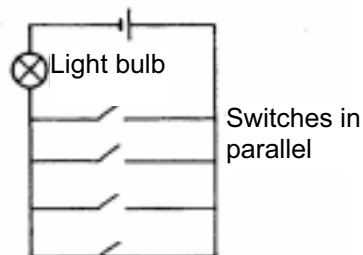

[5]

Page 5	Mark Scheme	Syllabus	Paper
	IGCSE – November 2005	0445	04

(ii)

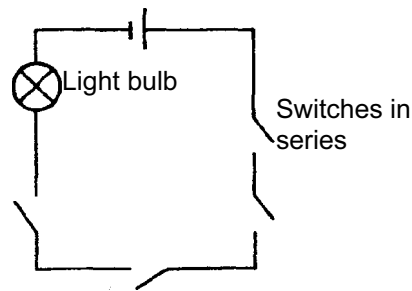

[5]

(iii) Toggle switch; slider switch

[1]

(b) (i) The resistor R_1 and capacitor C_1 act together (1) to create a delay (1) which can be varied according to their values (1). [3]

(ii) The transistor acts as a sensitive switch (1) to control the current flow (1) through the bulb (1). [3]

(iii) Electrolytic capacitors have polarity (1) and must be connected accordingly (1). Ceramic capacitors are usually small value capacitors and can be connected either way round (1) [3]

(c) (i)

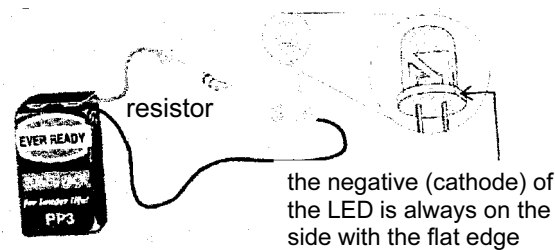

[3]

(ii) The resistor is a current limiting device (1) that will protect the LED (1) from overload (1) [3]

(d) Total Resistance = $V/I = 9/0.001 = 9000 \Omega$ (1)

$R_2 = V_2/I = 2/0.001 = 2000 \Omega$ (1)

Thus $R_1 + R_2 = 9000$ (1) and $R_1 = 9000 - 2000 = 7000$ (1)

[4]