



UNIVERSITY OF CAMBRIDGE INTERNATIONAL EXAMINATIONS  
International General Certificate of Secondary Education

CANDIDATE  
NAME

CENTRE  
NUMBER

--	--	--	--	--

CANDIDATE  
NUMBER

--	--	--	--



**AGRICULTURE**

**0600/02**

Paper 2

**October/November 2010**

**1 hour 15 minutes**

Candidates answer on the Question Paper.

No Additional Materials are required.

**READ THESE INSTRUCTIONS FIRST**

Write your Centre number, candidate number and name on all the work you hand in.  
Write in dark blue or black pen.  
You may use a soft pencil for any diagrams, graphs or rough working.  
Do not use staples, paper clips, highlighters, glue or correction fluid.  
**DO NOT WRITE IN ANY BARCODES.**

Answer **all** questions.

At the end of the examination, fasten all your work securely together.  
The number of marks is given in brackets [ ] at the end of each question or part question.

For Examiner's Use	
1	
2	
3	
4	
5	
6	
7	
8	
9	
<b>Total</b>	

This document consists of **16** printed pages.



- 1 Fig. 1.1 shows a Zebu cow from Africa.



Fig. 1.1

- (a) The cow provides the farmer's family with milk. The milk can be used to make butter and cheese.

Give **three** other products the cow provides and state what each can be used for.

.....  
 .....  
 ..... [3]

- (b) Which of the statements below relate to a cow?

Place a tick (✓) in the correct boxes.

it chews the cud

it has a large rumen

it stores food in a crop

it has a large caecum

it is a non-ruminant

it is a browser

it has four true stomachs

it produces methane

[3]

(c) State **two** ways to recognise ill health in a cow.

1 .....

.....

2 .....

..... [2]

(d) Fig. 1.2 is a picture of a South Devon bull. This breed is used in England for meat and milk production.



**Fig. 1.2**

Suggest **two** possible features of this breed that might make it ideal for crossing with Zebu cattle.

.....

.....

.....

..... [2]

[Total: 10]

2 (a) List the tasks that need to be carried out to replace forest with land ready for cultivation.

.....  
.....  
.....

[3]

(b) The land created from the forest would be liable to erosion.

(i) State **two** ways soil erosion might occur.

1 .....  
.....  
2 .....  
.....

[2]

(ii) State **two** ways this soil erosion could be reduced.

1 .....  
.....  
2 .....  
.....

[2]

(c) The land created from the forest would need to be fertilised before growing a crop.

Name an **inorganic** fertiliser that could be used to provide a field crop with

1 a supply of nitrogen, .....  
2 a supply of phosphorus. ....

[2]

[Total: 9]

3 (a) Fig. 3.1 shows two farm implements that are used to cultivate the soil.

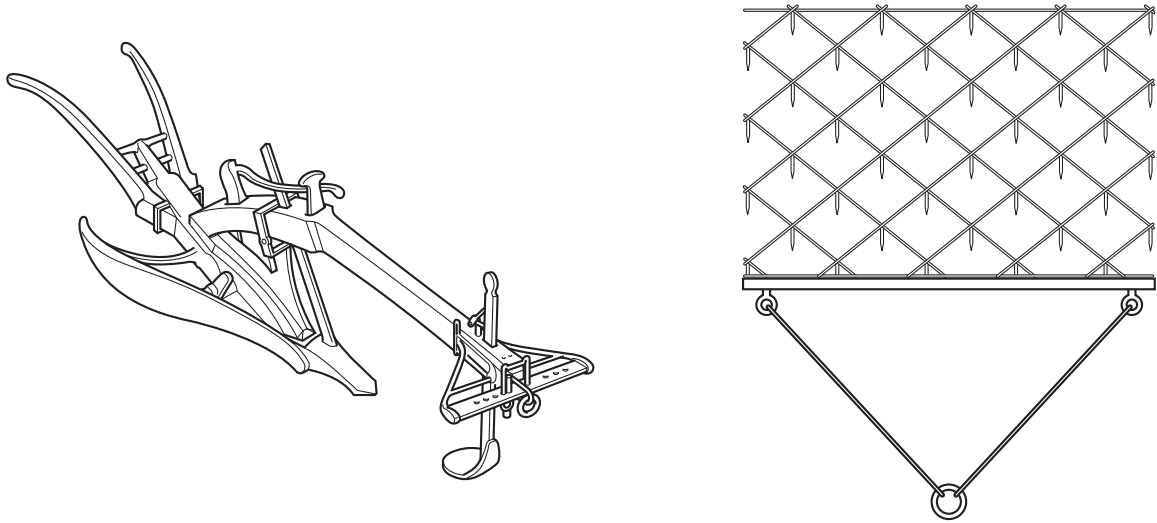

Fig. 3.1

(i) Name **two** tools that you could use in the garden that would do the same job when preparing a seed bed.

.....  
.....

[2]

(ii) Explain how each tool you mention could be used to prepare a seed bed in the garden.

.....  
.....  
.....  
.....  
.....

[2]

(b) What is meant by the term *soil crumb*?

.....  
.....  
.....

[2]

[Total: 6]

4 (a) Fig. 4.1 shows a soil profile.

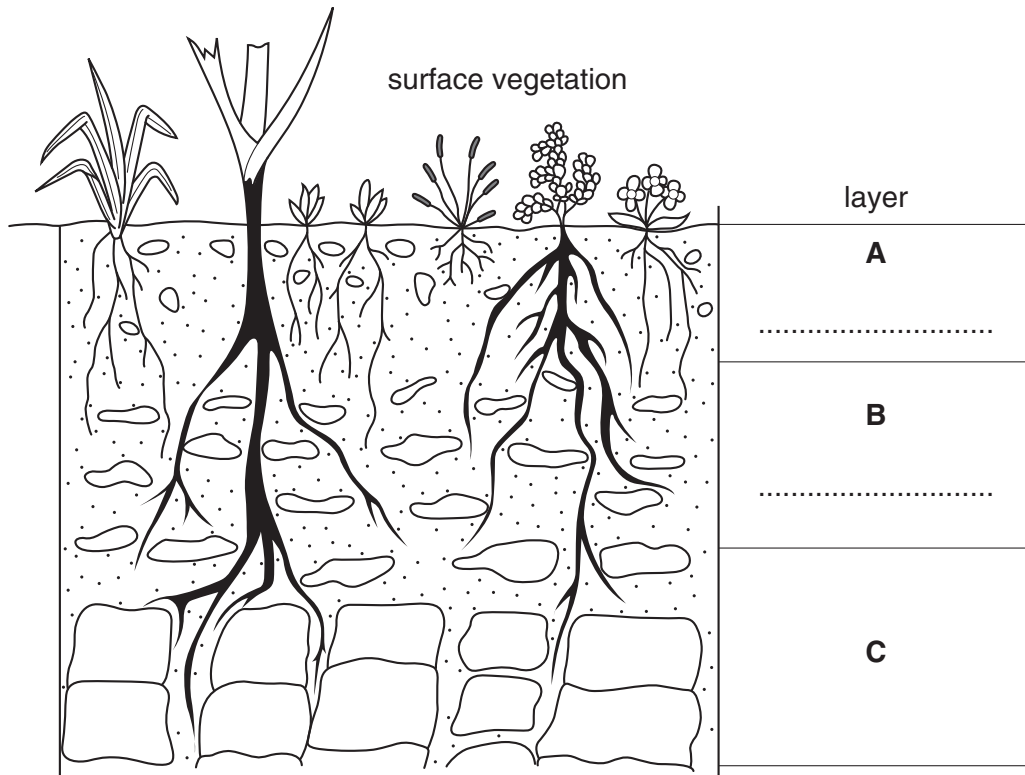

Fig. 4.1

(i) Label the parts **A** and **B** on the soil profile. [2]

(ii) In which layer, **A**, **B**, or **C**, would you expect to find most organic matter? [1]

.....

(iii) Which layer would you expect to have the highest temperature in the early morning?

.....

Give a reason for your answer.

.....

..... [2]

(b) Table 4.1 gives six tasks to do when carrying out a pH test.

Indicate the correct order of tasks.

1 (the first task) and 6 (the last task) have been done for you.

**Table 4.1**

	order of tasks
place soil sample in test tube	<b>1</b>
add distilled water	
add universal (soil) indicator	
add barium sulfate	
shake and leave	
compare with colour chart	<b>6</b>

[3]

(c) Fig. 4.2 shows a pH test using a probe. The soil sample being tested is from a pasture.

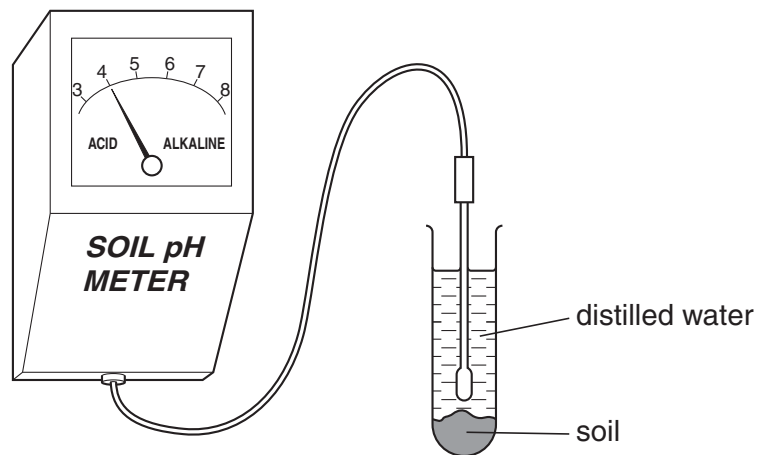

**Fig. 4.2**

The meter is showing the needle pointing at 4.0.

(i) What colour would **soil indicator** give if added to the test tube?

..... [1]

(ii) State **two** ways in which this pasture would benefit from liming.

.....  
 .....  
 ..... [2]

[Total: 11]

5 Fig. 5.1 shows the water cycle.

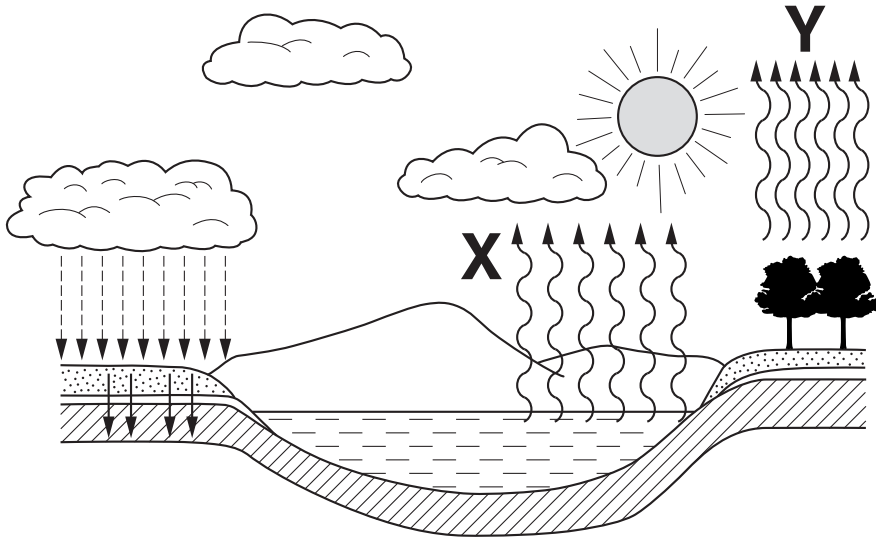

Fig. 5.1

(a) Name the processes taking place at X and Y.

X ..... Y ..... [2]

(b) State **two** uses of water to plants.

1 .....

2 ..... [2]

(c) What is meant by the term *osmosis*?

.....  
 .....  
 .....  
 ..... [2]



(d) Fig. 5.2 shows a plant.

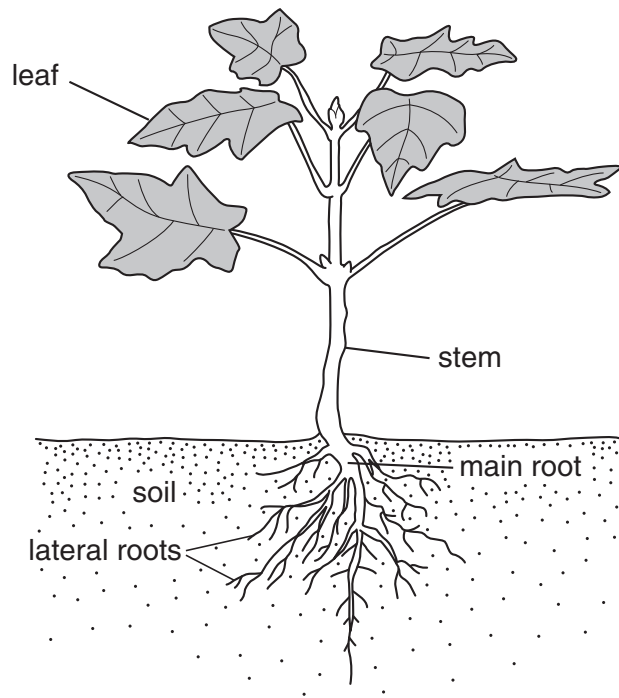

**Fig. 5.2**

(i) Water enters the lateral roots by osmosis.

Describe how the water gets to the leaves.

.....  
.....  
..... [2]

(ii) In dry conditions plants often wilt.

Explain how this might help a plant survive a period of drought.

.....  
.....  
..... [2]

[Total: 10]

6 (a) Fig. 6.1 shows the reproductive system of a male farm animal.

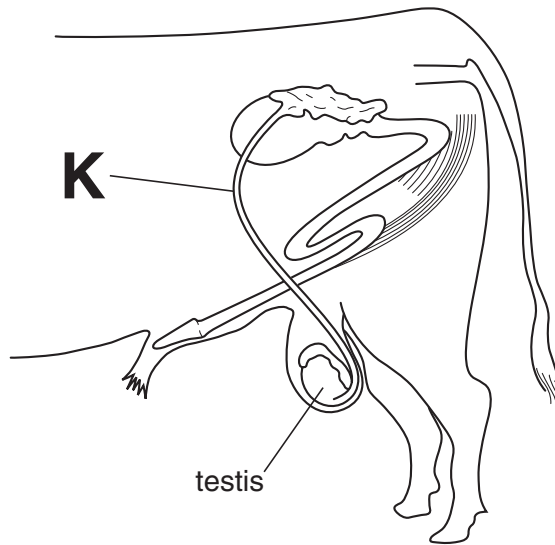

Fig. 6.1

(i) On Fig. 6.1 label the penis and the scrotum. [2]

(ii) What would be the effect on the animal of cutting the tube labelled K?  
..... [1]

(iii) What would be the effect on the growth of a young male animal if the testes were removed shortly after birth?  
.....  
..... [1]

(b) Describe the process of birth in a farm animal.  
.....  
.....  
.....  
..... [3]

(c) State the importance of colostrum to a young animal.  
.....  
..... [1]

[Total: 8]

7 (a) Fig. 7.1 shows a farm that is divided up into paddocks.

The farmer intends to keep sheep.

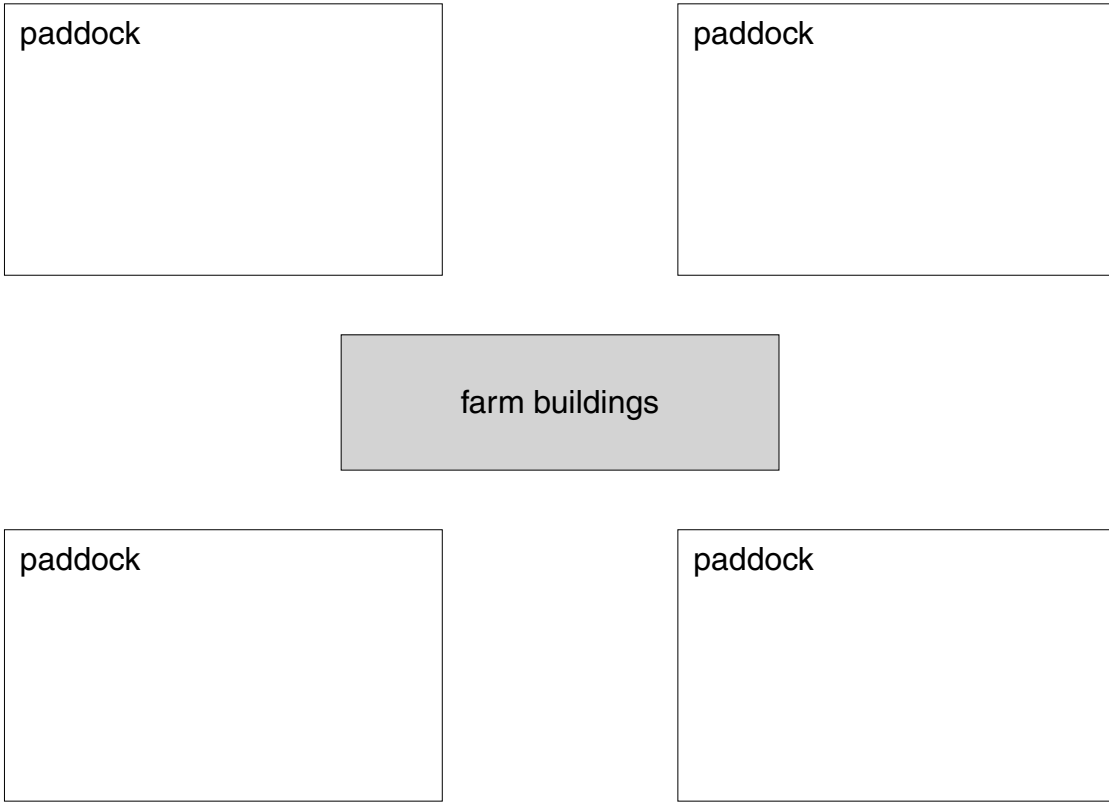

Fig. 7.1

(i) Explain on Fig. 7.1 how the paddocks could be used for the rotational grazing of sheep. [2]

(ii) State **two** advantages of rotational grazing.

- 1 .....
- .....
- 2 .....
- ..... [2]

(iii) What is meant by the term *zero grazing*?

- .....
- ..... [1]

(b) Table 7.1 gives some data on sheep behaviour.

This data was collected by observing 20 sheep every hour, on the hour, during one summer day.

Their activity at the time of observation was recorded under four headings.

**Table 7.1**

time of day / hrs	activity			
	grazing	chewing the cud	lying down	other activity e.g. rubbing/fighting
0700	18			2
0800	16	1		3
0900	12	5	2	1
1000	1	17		2
1100		16	3	1
1200		5	13	2
1300		1	19	
1400	3		16	1
1500	15		2	3
1600	18			2

State **two** conclusions about the behaviour of sheep that can be made from this table.

1 .....

.....

2 .....

..... [2]

[Total: 7]

8 (a) Fig. 8.1 shows a fence for enclosing cattle and sheep.

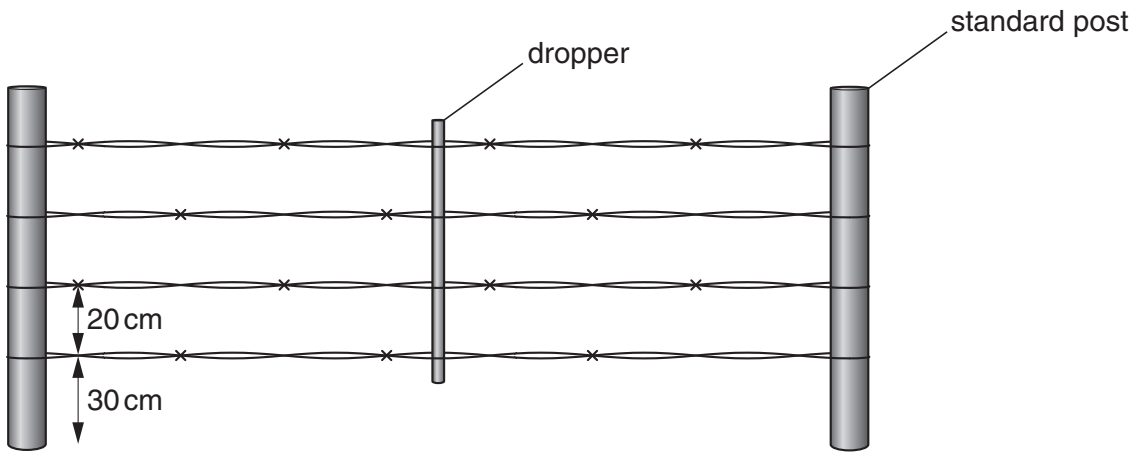

Fig. 8.1

(i) Suggest how this fence could be adapted to keep out wild game such as deer and antelopes.

.....  
..... [1]

Fence posts can be made of wood, metal and concrete.

(ii) State **one** reason, other than cost, for using:

wooden posts, .....  
.....  
metal posts. ....  
..... [2]

(iii) Suggest how to make concrete fence posts.

.....  
.....  
.....  
..... [3]

(b) Concrete can also be used in the construction of dam walls.

For  
Examiner's  
Use

Fig. 8.2 shows a shallow dam used for storing water.

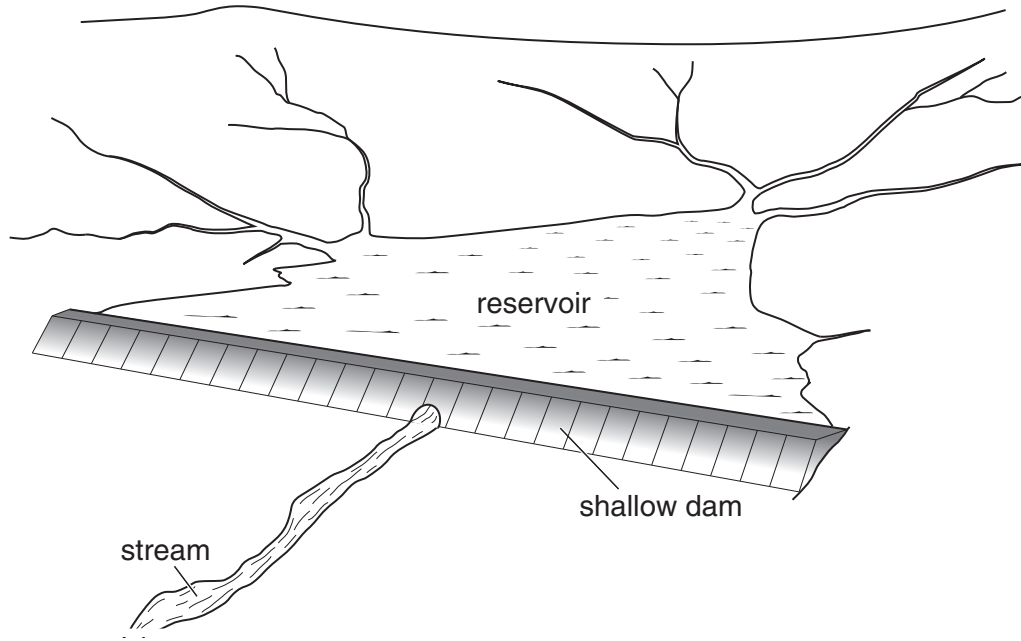

Fig. 8.2

(i) State **one** problem which may arise from the use of shallow dams.

.....  
 ..... [1]

(ii) Explain why the front wall of a dam is built with a sloping wall.

.....  
 .....  
 ..... [2]

[Total: 9]

9 (a) Fig. 9.1 shows the mouthparts of two insects which feed by biting and chewing.



Fig. 9.1

(i) Explain why insects like these damage crops and reduce yield.

.....  
.....  
.....  
.....  
..... [3]

(ii) Suggest a way to control these insects in the field.

.....  
..... [1]

(b) Plants are also harmed by diseases.

Name a plant disease that is caused by:

bacteria, .....

fungi, .....

viruses. ....

[3]

(c) This question is about size.

Match the item in the left hand column with the correct size on the right.

One has been done for you.

item	decreasing size
bacterium	1 – 2 cm
clay particle	0.02 – 2.00 mm
bean pollen grain	0.002 mm – 0.02 mm
bean seed	0.0002 mm – 0.002 mm
sand particle	0.5 $\mu\text{m}$ – 2.0 $\mu\text{m}$
virus	0.0002 $\mu\text{m}$ – 0.002 $\mu\text{m}$

[3]

[Total: 10]

For  
Examiner's  
Use

Copyright Acknowledgements:

Question 1 Figure 1.1 © Photograph of Zebu cow and calf; Boran Genetics.

Permission to reproduce items where third-party owned material protected by copyright is included has been sought and cleared where possible. Every reasonable effort has been made by the publisher (UCLES) to trace copyright holders, but if any items requiring clearance have unwittingly been included, the publisher will be pleased to make amends at the earliest possible opportunity.

University of Cambridge International Examinations is part of the Cambridge Assessment Group. Cambridge Assessment is the brand name of University of Cambridge Local Examinations Syndicate (UCLES), which is itself a department of the University of Cambridge.