



UNIVERSITY OF CAMBRIDGE INTERNATIONAL EXAMINATIONS
International General Certificate of Secondary Education

BIOLOGY

0610/01

Paper 1 Multiple Choice

October/November 2008

45 minutes

Additional Materials: Multiple Choice Answer Sheet
Soft clean eraser
Soft pencil (type B or HB is recommended)



READ THESE INSTRUCTIONS FIRST

Write in soft pencil.

Do not use staples, paper clips, highlighters, glue or correction fluid.

Write your name, Centre number and candidate number on the Answer Sheet in the spaces provided unless this has been done for you.

There are **forty** questions on this paper. Answer **all** questions. For each question there are four possible answers **A, B, C** and **D**.

Choose the **one** you consider correct and record your choice in **soft pencil** on the separate Answer Sheet.

Read the instructions on the Answer Sheet very carefully.

Each correct answer will score one mark. A mark will not be deducted for a wrong answer.
Any rough working should be done in this booklet.

This document consists of **19** printed pages and **1** blank page.



1 Which characteristic is shown by all living things?

- A breathing
- B growing
- C sleeping
- D walking

2 The diagrams show four different animals. They are not drawn to the same scale.

W

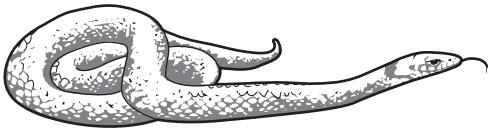

X

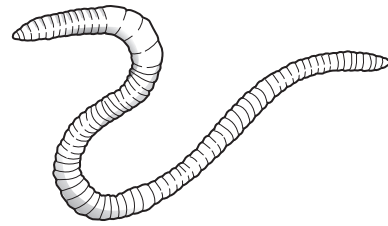

Y



Z

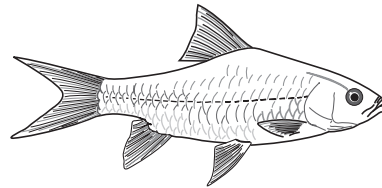

Which are vertebrates?

- A W and X
- B X and Y
- C Y and Z
- D W and Z

3 The diagram shows half a flower.



The following key may be used to identify the plant on which the flower is growing.

- 1 petals separate from sepals go to 2
 petals and sepals joined plant P
- 2 flower with four stamens plant Q
 flower with more than four stamens go to 3
- 3 ovary as tall as wide plant R
 ovary taller than wide go to 4
- 4 flower has two petals plant S
 flower has more than two petals plant T

To which plant does the flower belong?

- A** plant P **B** plant Q **C** plant R **D** plant T

4 Which two functions does xylem perform?

	absorption	conduction	contraction	support
A	✓	x	✓	x
B	✓	✓	x	x
C	x	x	✓	✓
D	x	✓	x	✓

key

✓ = performs

x = does not perform

5 The diagram shows a cell.

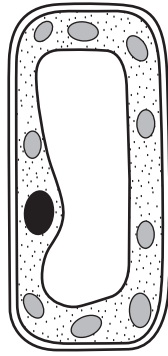

What type of cell is shown?

- A epidermis
- B muscle
- C nerve
- D palisade

6 Which diagram shows a cell from the liver?

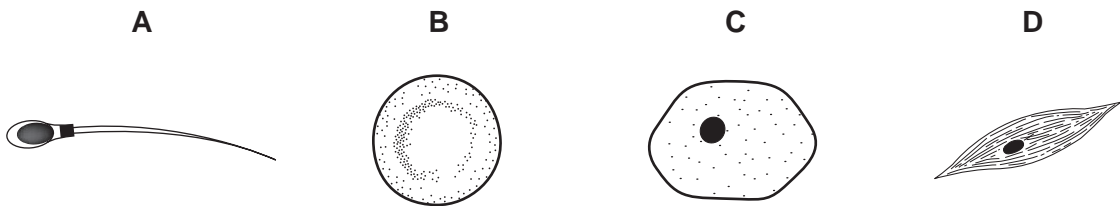

7 The diagrams show a leaf and a section through part of the same leaf.

Which label on the diagrams indicates an organ?

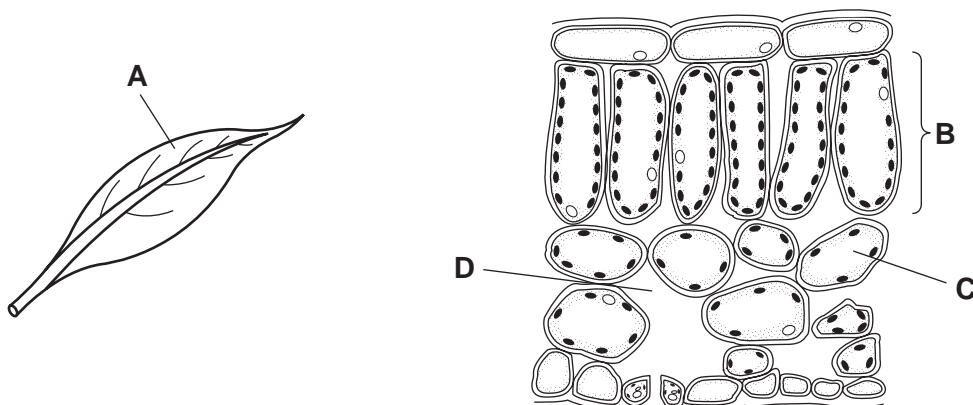

- 8 What is the main function of muscle?
- A absorption
 - B conduction
 - C contraction
 - D transport
- 9 Which two features are found in both a root hair cell and a red blood cell?
- A cell membrane and cytoplasm
 - B cell membrane and vacuole
 - C nucleus and chloroplast
 - D nucleus and cytoplasm
- 10 What controls the passage of substances into and out of plant cells?
- A the cell surface membrane
 - B the cellulose cell wall
 - C the chloroplasts
 - D the vacuole
- 11 An experiment on diffusion was set up as shown in the diagram.

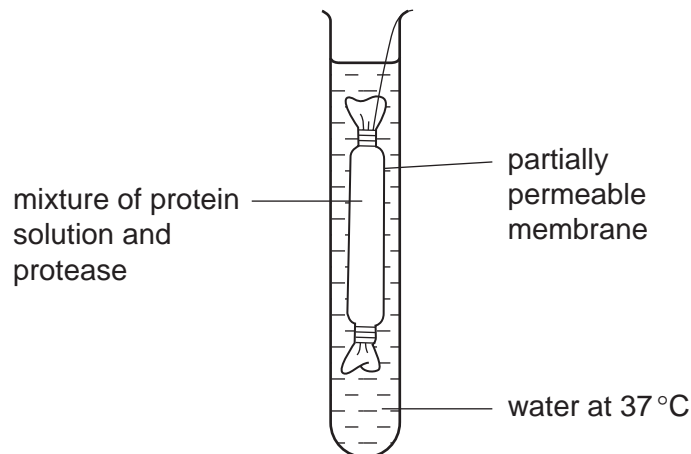

What was found in the water after 15 minutes?

- A amino acids
- B fatty acids
- C glucose
- D glycerol

12 Which substance is an enzyme?

- A bile
- B fibrinogen
- C lipase
- D maltose

13 The diagram shows the human alimentary canal.

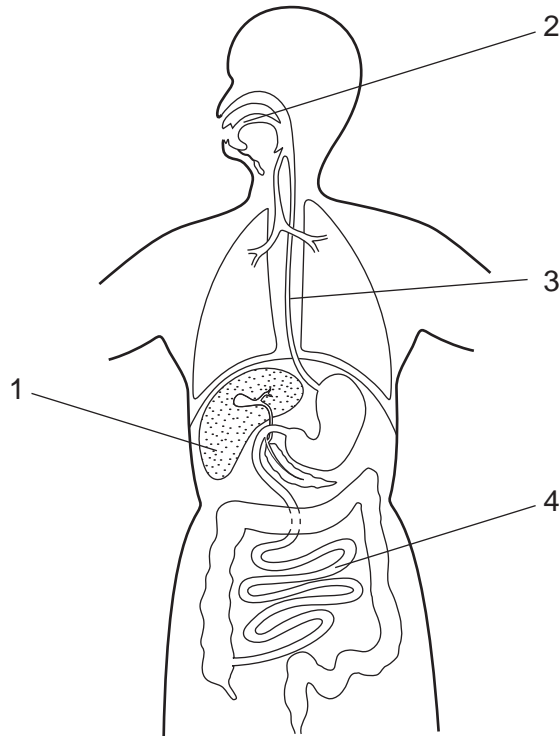

In which parts does peristalsis take place?

- A 1 and 2
- B 2 and 3
- C 3 and 4
- D 4 and 1

14 Some liquid is collected from the xylem in the stem of a plant.

What is present in the liquid?

- A amino acids
- B inorganic ions
- C starch
- D sugar

- 15 The diagram shows cells from a storage organ of a flowering plant after they have been stained with iodine solution.

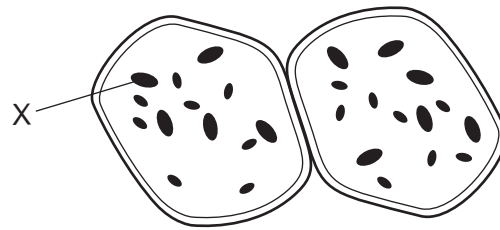

Structures X stain black.

What does this show that structures X contain?

- A chlorophyll
 - B fat
 - C starch
 - D sugar
- 16 The diagram shows a double circulatory system.

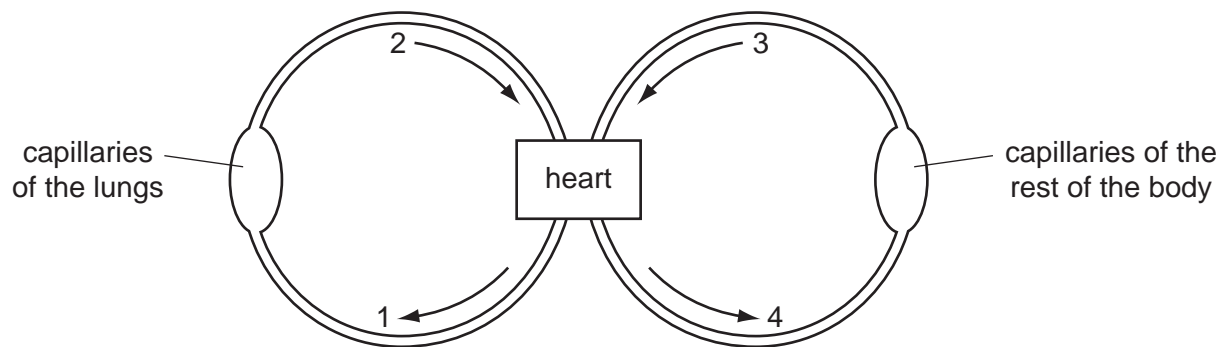

Which two vessels carry blood at the highest pressure?

- A 1 and 2
- B 1 and 4
- C 2 and 3
- D 2 and 4

17 The diagram shows an external view of the human heart.

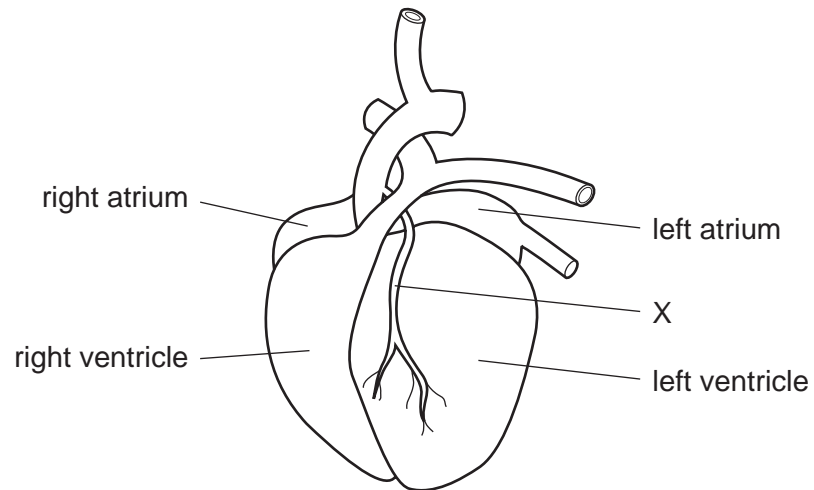

What is the name of the blood vessel labelled X?

- A coronary artery
- B hepatic artery
- C pulmonary artery
- D renal artery

18 The diagram shows two shoots at the start of an experiment on transpiration.

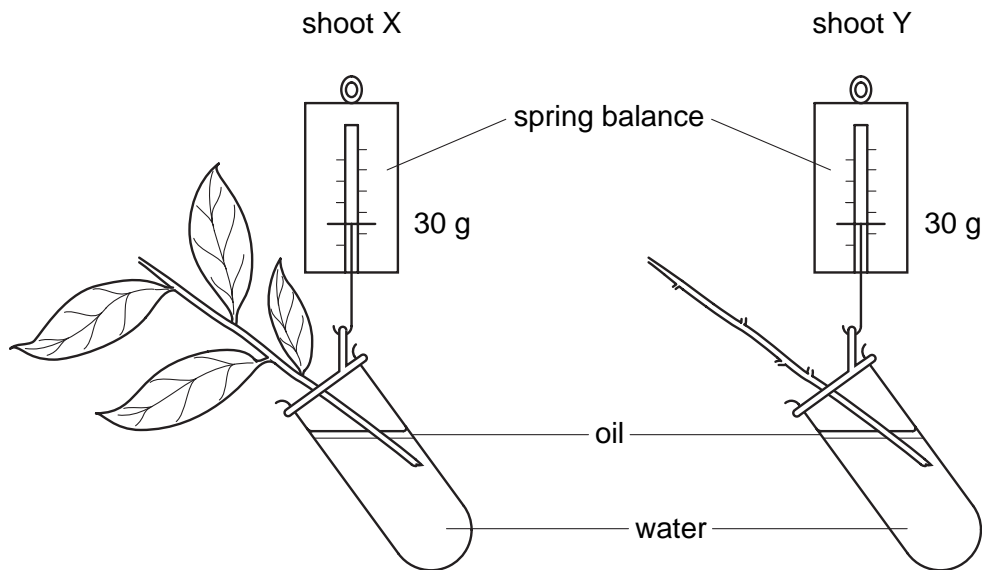

What are the readings on the spring balances after three days?

	shoot X	shoot Y
A	30 g	30 g
B	30 g	25 g
C	25 g	30 g
D	25 g	25 g

19 What is the role of anaerobic respiration in bread-making?

- A** to produce alcohol to flavour the bread
- B** to produce gas to make the bread rise
- C** to release enough energy to bake the bread
- D** to release enough lactic acid to kill the yeast

20 Gas exchange in annelid worms occurs through the whole of the skin surface.

What are the most likely characteristics of the skin surface?

	surface area to volume ratio	condition of surface
A	large	dry
B	large	wet
C	small	dry
D	small	wet

- 21 An athlete runs a race. The graph shows how the concentration of lactic acid in his leg muscles changes.

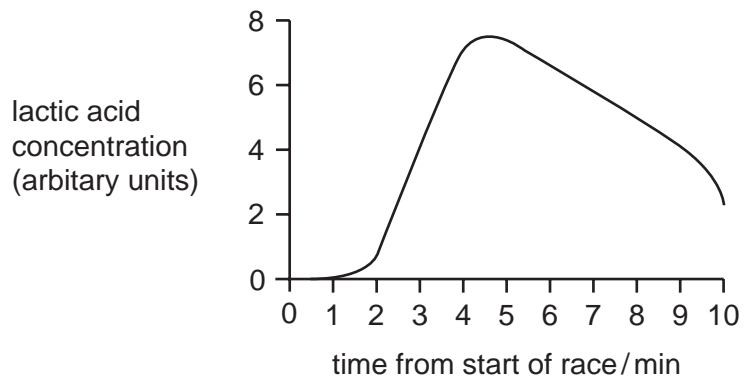

For how long did the athlete run?

- A 2 minutes
 - B 4 minutes
 - C 6 minutes
 - D 10 minutes
- 22 The diagram shows the human excretory system and its main associated blood vessels.

Which labelled structure contains urine?

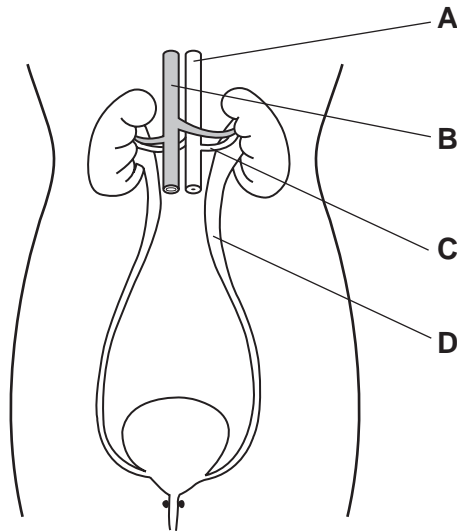

- 23 The table shows the amount of water and salt lost from the kidneys and skin on a hot day and on a cold day. Food and drink intake are the same on both days.

	water lost from kidneys/dm ³	water lost from skin/dm ³	salt lost from kidney/g	salt lost from skin/g
cold day	1.8	0.0	20.2	0.0
hot day	0.4	2.3	14.4	5.8

What do these results show?

- A** Less water is lost from the kidneys on a cold day than on a hot day.
B More salt is lost from the kidneys on a hot day than on a cold day.
C The total amount of salt lost each day is the same.
D Water is not lost from the kidneys on hot days.
- 24 The diagram shows bones and muscles in the human arm.

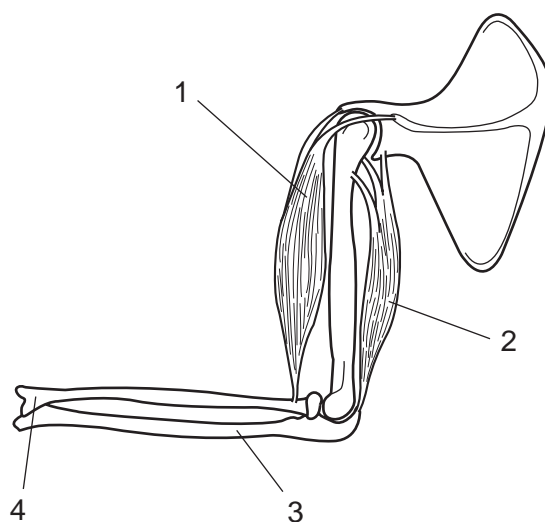

Which row correctly identifies the biceps, triceps and ulna?

	biceps	triceps	ulna
A	1	2	4
B	1	2	3
C	2	1	4
D	2	1	3

- 25 The diagram shows the apparatus used to investigate the effect of light on the growth of three plant shoots.

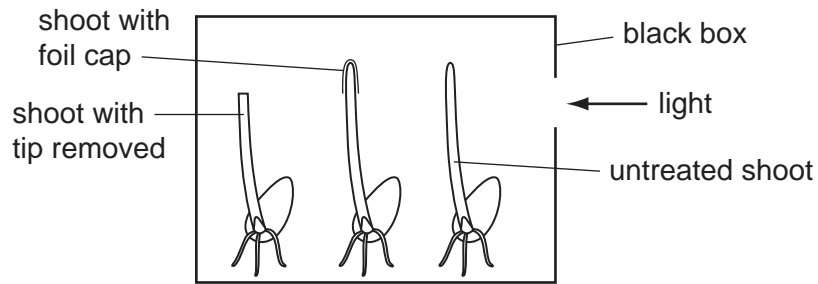

Which diagram shows the likely result after one day?

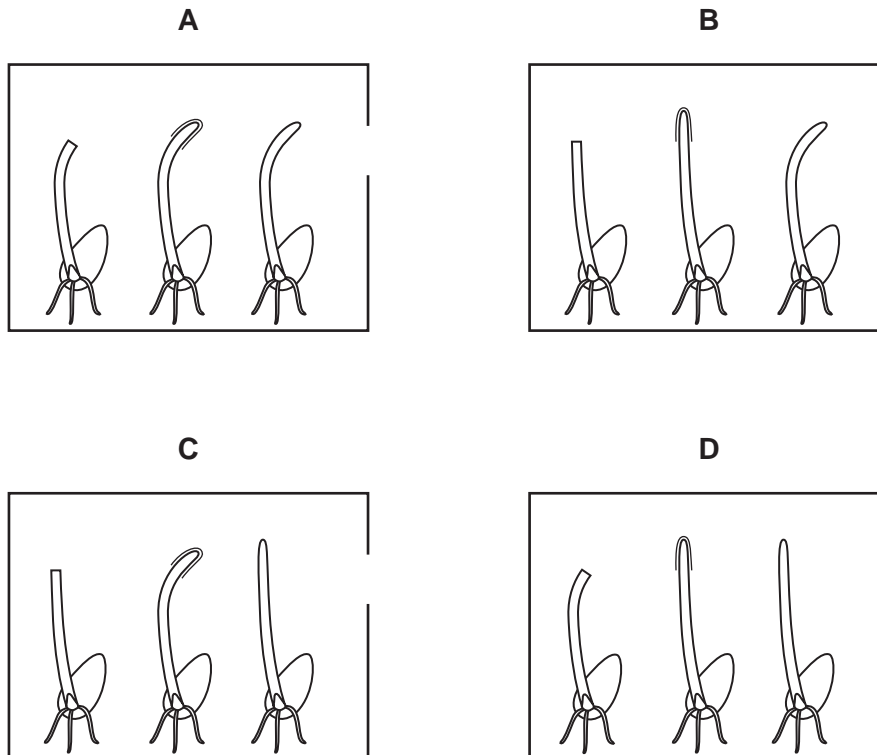

- 26 Some couples who do not want to have babies avoid sexual intercourse for certain days in the woman's menstrual cycle.

Which kind of birth control is this?

- A chemical
- B mechanical
- C natural
- D surgical

27 Seed dispersal, fertilisation, seed germination and pollination are processes in plant reproduction.

What is the correct sequence for events after pollination?

- A dispersal → fertilisation → germination
- B dispersal → germination → fertilisation
- C fertilisation → dispersal → germination
- D germination → fertilisation → dispersal

28 What is **not** normally essential for germination?

- A enzymes
- B light
- C oxygen
- D warmth

29 The diagrams show a camel before and after drinking a large volume of water.

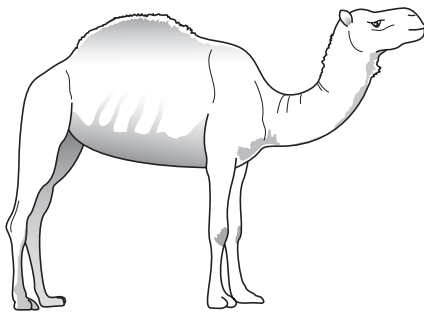

before

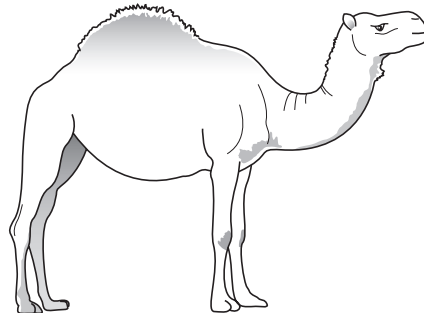

after

Which statement is correct?

- A Growth has occurred because the animal has increased in volume.
- B Growth has occurred because the animal has increased in mass.
- C Growth has not occurred because the animal's height is unaltered.
- D Growth has not occurred because the dry mass has not increased.

30 The nucleus in each cell in the stem of a plant contains 32 chromosomes.

How many chromosomes are there in the nuclei of its pollen grains?

- A 8
- B 16
- C 32
- D 64

31 The diagram shows the offspring of a cross between two wolves.

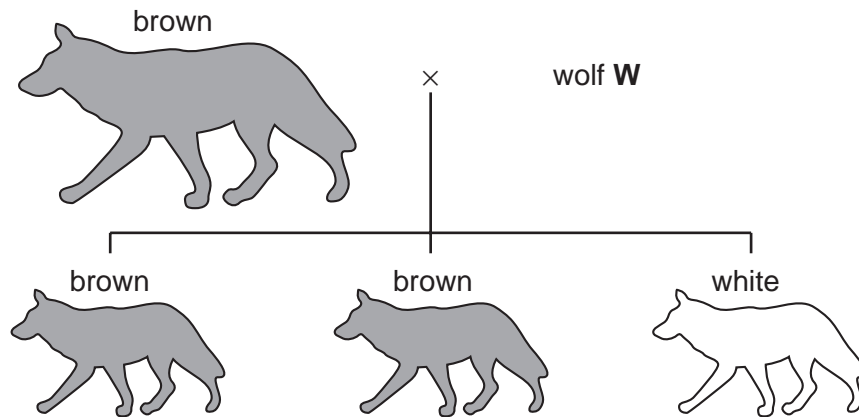

Brown colour is caused by a dominant allele B and white colour by a recessive allele b.

What are the genotype and the phenotype of wolf **W**?

	genotype	phenotype
A	B	brown
B	Bb	brown
C	brown	B
D	brown	Bb

32 What is an advantage of a short food chain?

- A** A few producers can support a large number of consumers.
- B** It is easier for consumers to find food.
- C** Less energy is lost in the food chain.
- D** Less food is required by the consumers.

33 Fungi are decomposers.

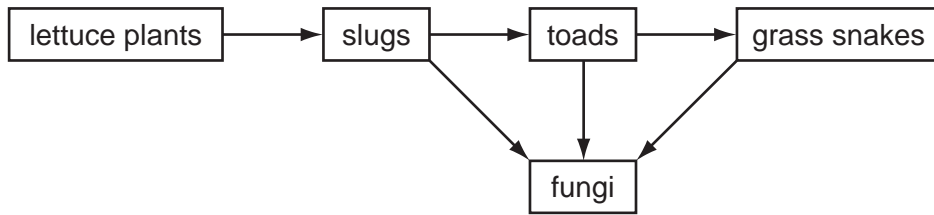

Why are they important in the food web?

- A They provide food for snakes.
- B They control the numbers of toads.
- C They provide energy for plant growth.
- D They release minerals essential for plant growth.

34 A single tree is food for a large population of caterpillars. Several small birds eat the caterpillars. The small birds are eaten by a bird of prey.

Which is the pyramid of biomass?

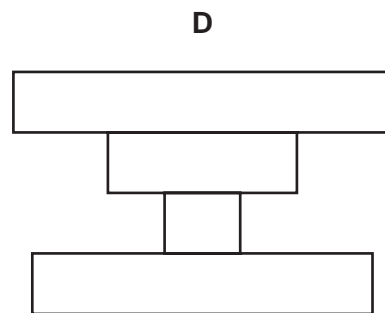
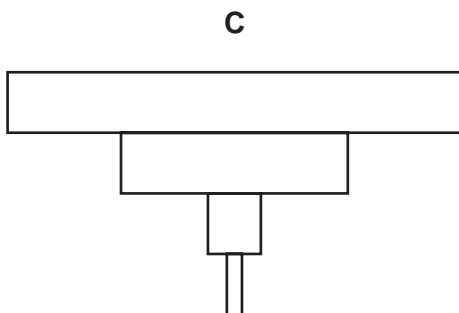
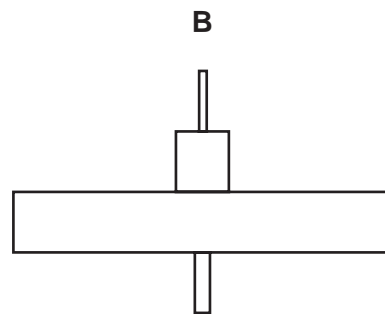
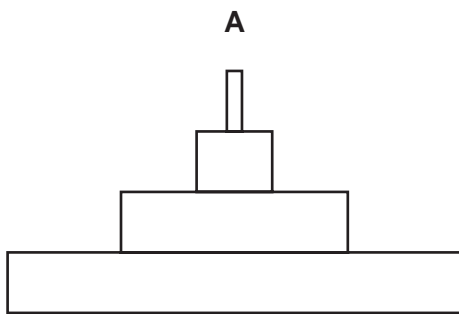

35 The diagram shows part of the carbon cycle.

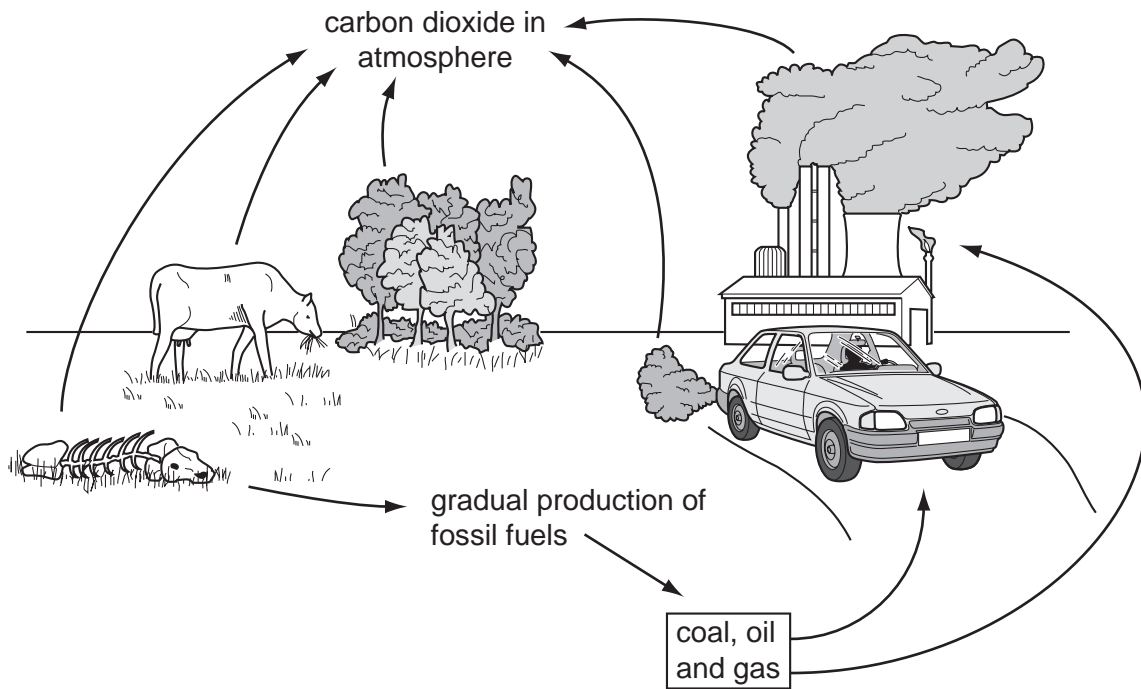

Which process is missing from the diagram?

- A combustion
- B photosynthesis
- C respiration
- D transpiration

- 36 The diagram shows the water cycle. The arrows show four processes that take place during this cycle.

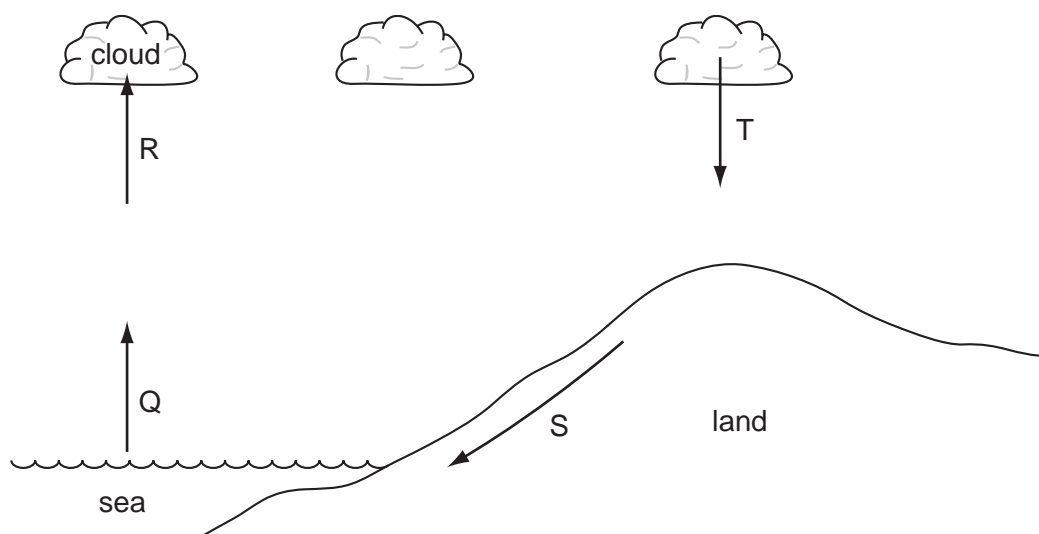

Which combination identifies these processes?

	condensation	evaporation	precipitation
A	Q	R	T
B	R	Q	T
C	R	S	T
D	S	Q	R

- 37 The populations of four organisms in a lake were measured between 1908 and 1990.

Which organism was affected by an outbreak of disease in 1984?

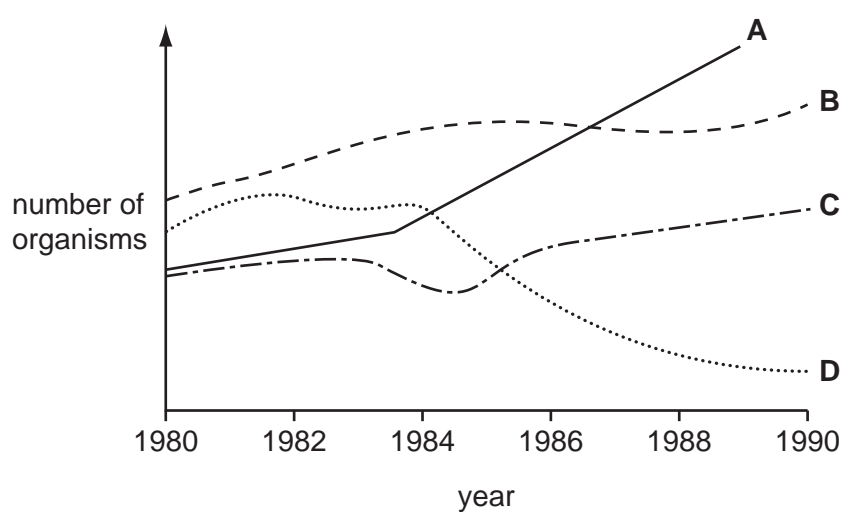

38 Lichens are organisms that do **not** grow well in air containing sulphur dioxide.

Which graph shows the change in number of lichen species from the centre of an industrial city to a country area 15 km away?

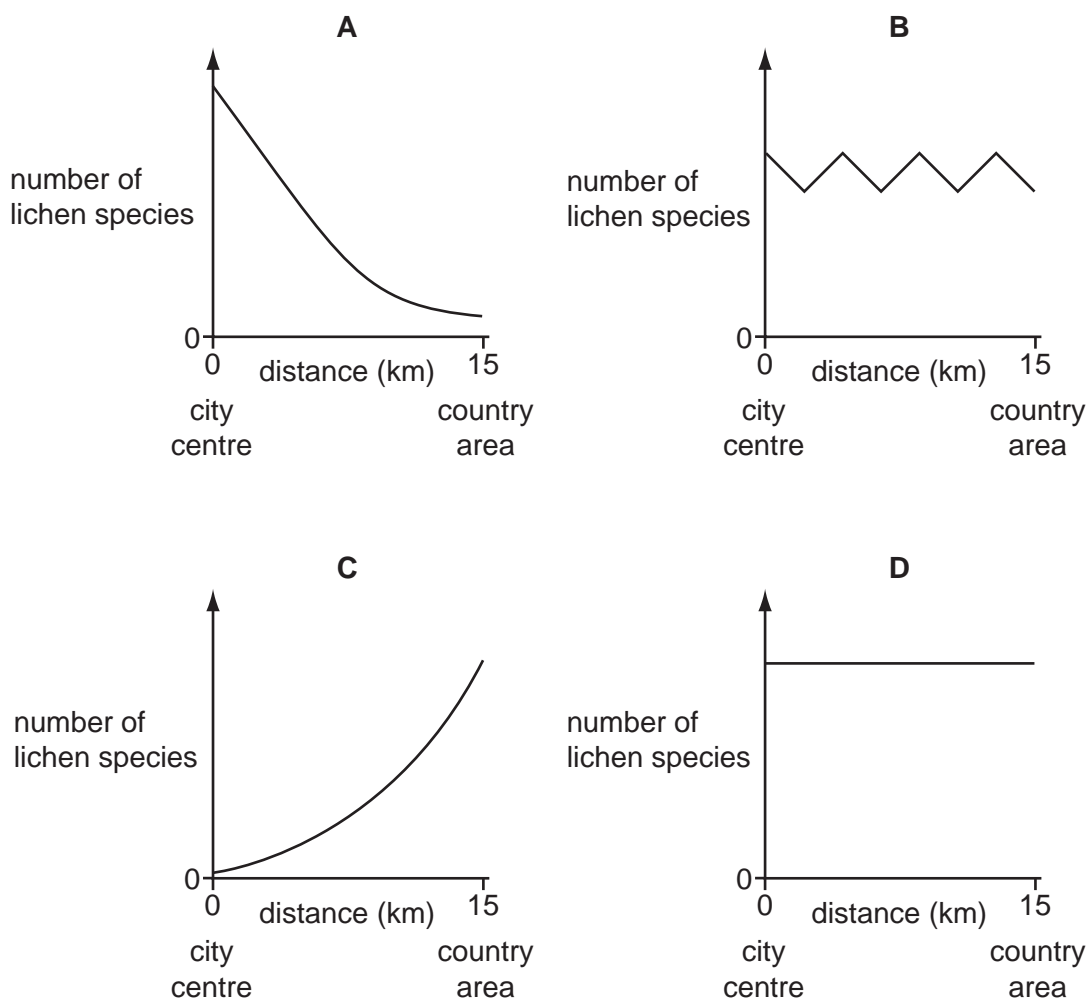

39 Four water samples are collected from different places along a river. The average number of organisms per species and the number of different species of organisms are counted.

The table shows the results.

Which water sample is most polluted?

	average number of organisms per species	number of species
A	650	5
B	280	30
C	400	17
D	420	43

- 40 The graph shows how the concentration of oxygen and the numbers of fish and bacteria in a river change when sewage flows into it.

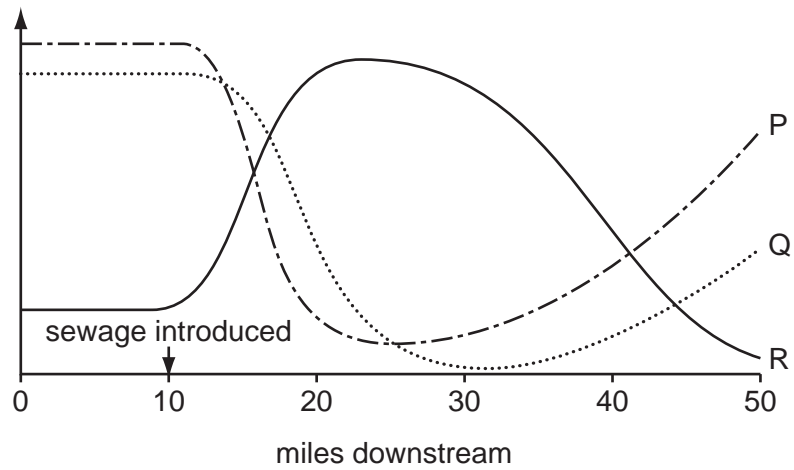

What are P, Q and R?

	P	Q	R
A	bacteria	oxygen	fish
B	fish	bacteria	oxygen
C	fish	oxygen	bacteria
D	oxygen	fish	bacteria

BLANK PAGE

Permission to reproduce items where third-party owned material protected by copyright is included has been sought and cleared where possible. Every reasonable effort has been made by the publisher (UCLES) to trace copyright holders, but if any items requiring clearance have unwittingly been included, the publisher will be pleased to make amends at the earliest possible opportunity.

University of Cambridge International Examinations is part of the Cambridge Assessment Group. Cambridge Assessment is the brand name of University of Cambridge Local Examinations Syndicate (UCLES), which is itself a department of the University of Cambridge.