



Cambridge IGCSE®

CANDIDATE
NAME

--

CENTRE
NUMBER

--	--	--	--	--

CANDIDATE
NUMBER

--	--	--	--



BIOLOGY

0610/03

Paper 3 Theory (Core)

For examination from 2020

SPECIMEN PAPER

1 hour 15 minutes

Candidates answer on the question paper.

No additional materials are required.

READ THESE INSTRUCTIONS FIRST

Write your centre number, candidate number and name on all the work you hand in.

Write in dark blue or black pen.

You may use an HB pencil for any diagrams, graphs or rough working.

Do not use staples, paper clips, glue or correction fluid.

DO NOT WRITE IN ANY BARCODES.

Answer **all** questions.

Electronic calculators may be used.

You may lose marks if you do not show your working or if you do not use appropriate units.

At the end of the examination, fasten all your work securely together.

The number of marks is given in brackets [] at the end of each question or part question.

This document consists of **16** printed pages and **2** blank pages.

- 1 All living organisms show the same seven characteristics. These are listed below, along with their definitions.

Match the characteristics and definitions by drawing lines between them on the diagram below. One has been done for you.

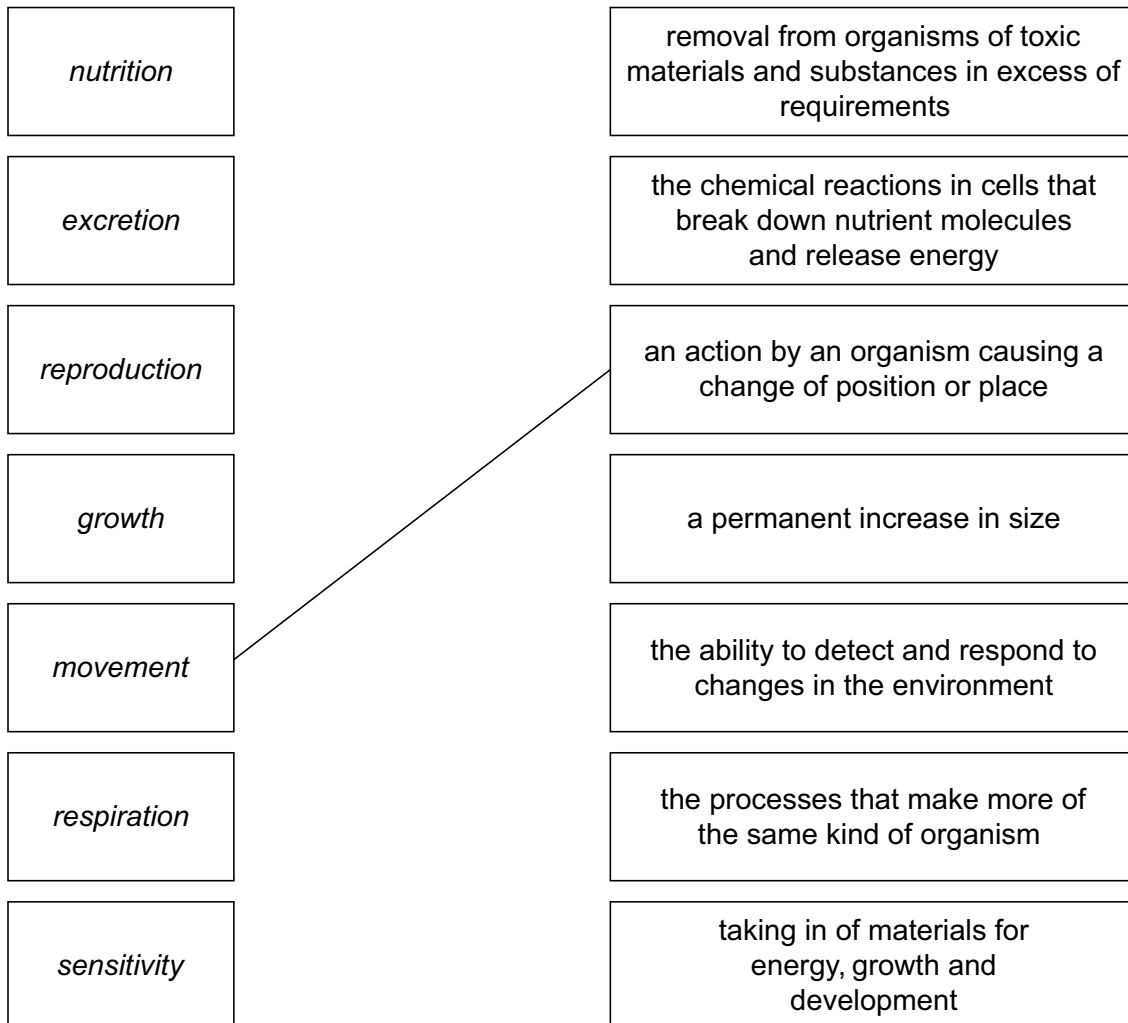

[6]

[Total: 6]

2 The animal in Fig. 2.1 is a chimpanzee.



Fig. 2.1

(a) (i) The chimpanzee is a vertebrate.
State the main group of vertebrates to which the chimpanzee belongs.
..... [1]

(ii) State **two** features, visible in Fig. 2.1, which suggest that it belongs to this group of vertebrates.
1
2 [2]

(b) The chimpanzee lives in forests in central and western Africa. The chimpanzee is classified as an endangered species because its population has decreased greatly.
(i) Suggest why the chimpanzee population has decreased.
.....
.....
.....
..... [2]

(ii) Describe how a captive breeding programme can help to conserve chimpanzees in the wild.
.....
.....
.....
..... [2]

(iii) State **two** methods, other than captive breeding, of conserving endangered species.

1

2 [2]

[Total: 9]

3 Fig. 3.1 shows a fetus developing inside the uterus.

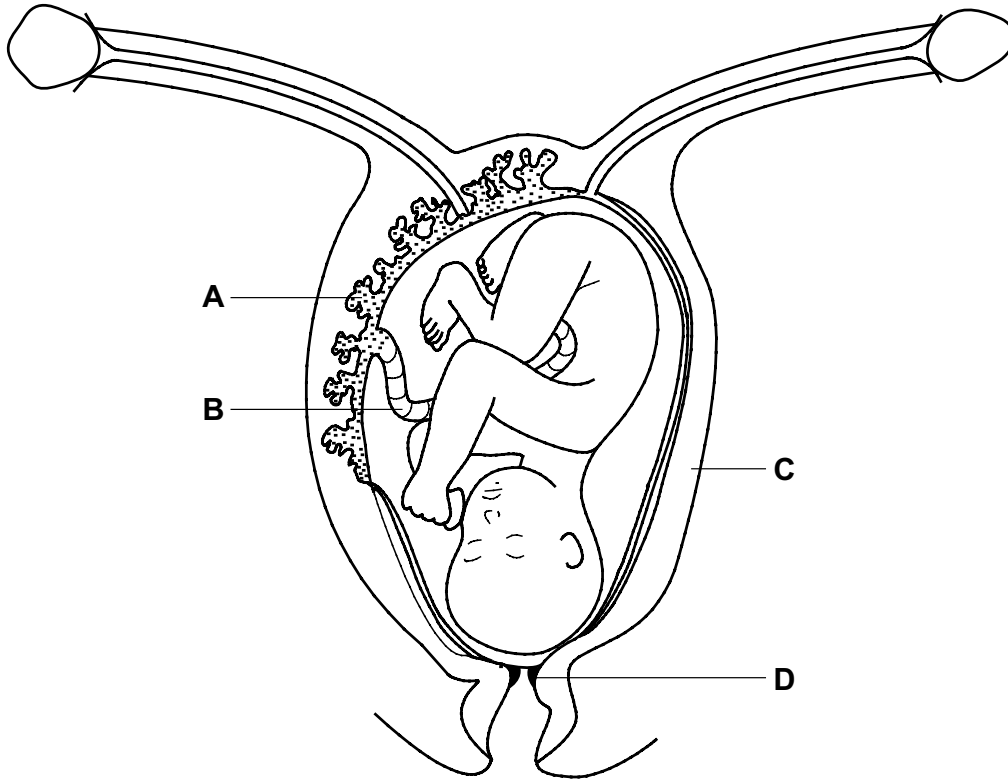

Fig. 3.1

(a) The fetus developed from a fertilised egg cell.

Put an X on Fig. 3.1 to show where an egg cell is normally fertilised.

[1]

(b) State the functions of the structures labelled A and B.

A

B [2]

(c) Describe the roles of the structures labelled C and D during labour and birth.

C

.....

D

..... [2]

[Total: 5]

4 Fig. 4.1 shows a model of how an enzyme works.

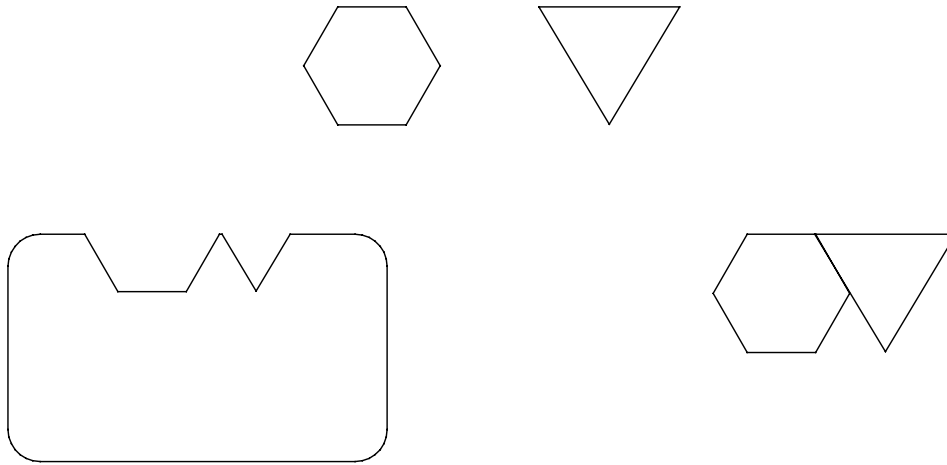

Fig. 4.1

(a) Label the enzyme molecule on Fig. 4.1.

[1]

(b) Enzymes are biological catalysts.

(i) Explain what is meant by the term *catalyst*.

.....
.....
.....
..... [2]

(ii) State why enzymes are important in organisms.

.....
..... [1]

[Total: 4]

5 In the Arctic, snowy owls are predators of lemmings. The lemmings eat Arctic plants.

(a) Draw the food chain for this Arctic ecosystem.

..... [1]

(b) Fig. 5.1 shows changes in the populations of snowy owls and lemmings over a three year period.

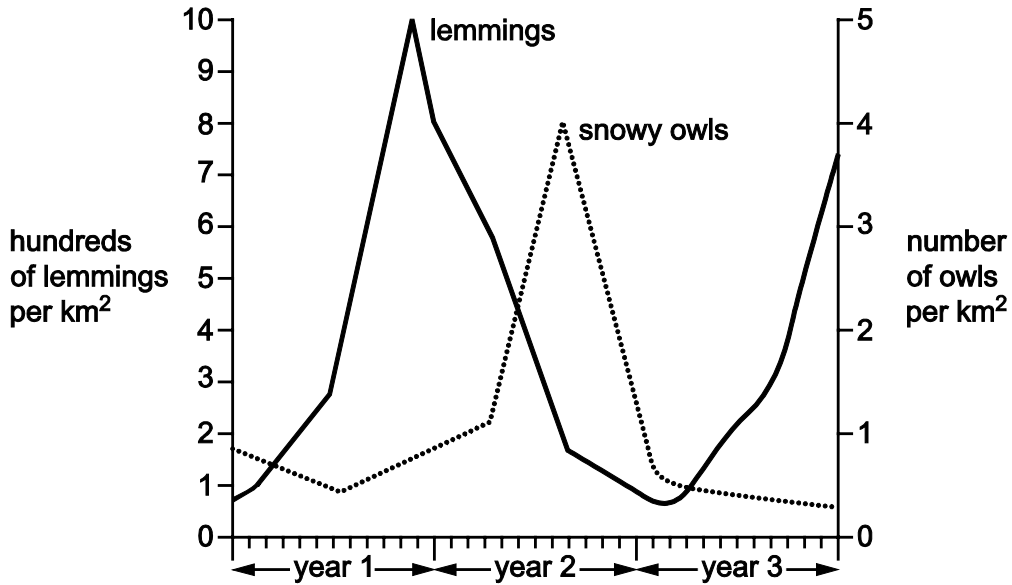

Fig. 5.1

During the first 10 months of year 1, the lemming population increases slowly at first and then more rapidly.

(i) Suggest why the rate of increase becomes greater.

.....
 [1]

(ii) Suggest why the lemming population falls during year 2.

.....

 [2]

(iii) Use Fig. 5.1 to describe and explain how changes in the lemming population affect the snowy owl population.

.....

.....

.....

.....

.....

.....

..... [3]

(iv) If all the snowy owls were removed from the Arctic ecosystem, suggest and explain what effect this would have on the lemming population in the following years.

.....

.....

.....

.....

.....

.....

..... [3]

(c) Lemmings and snowy owls get their energy from the food they eat.

(i) State the principal source of all the energy in this ecosystem.

..... [1]

(ii) Name the process that first traps this energy.

..... [1]

[Total: 12]

6 (a) What term is used to describe 'disease-causing organisms'?
..... [1]

(b) Fig. 6.1 shows some virus particles that cause the transmissible disease, influenza.

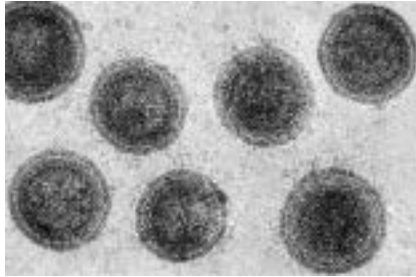

Fig. 6.1

Suggest how the virus particles that cause influenza are transmitted from one person to another.

.....
.....
.....
..... [2]

(c) Describe the defences of the body which prevent or fight infection.
.....
.....
.....
.....
.....
..... [3]

(d) Explain why antibiotics are **not** successful in treating influenza.
.....
.....
.....
..... [2]

[Total: 8]

7 Fig. 7.1 shows a section through a flower.

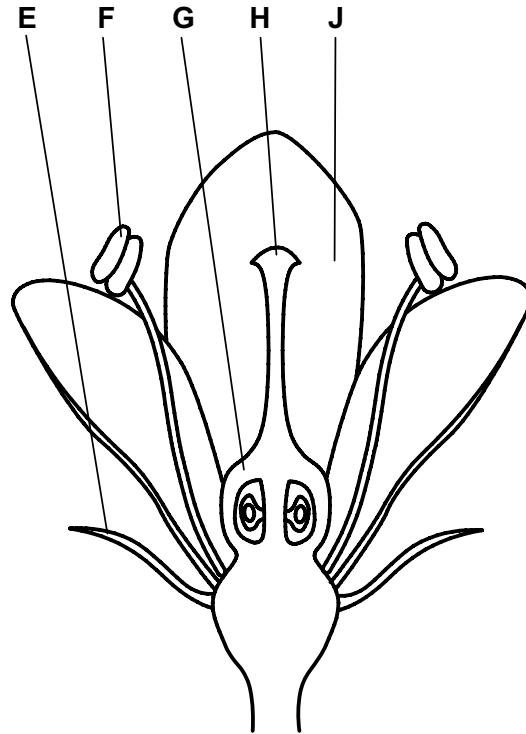

Fig. 7.1

(a) (i) Write **one** letter from Fig. 7.1 to identify **each** of the following. You may use each letter once, more than once, or not at all.

- petal [6]
- anther
- stigma
- a male part of the flower
- a part of the carpel
- sepal

(ii) Describe the evidence that this flower is pollinated by insects.

..... [2]

.....

.....

.....

(b) Fig. 7.2 shows pollen grains from the flowers of several different species, labelled with the letters K–Q.

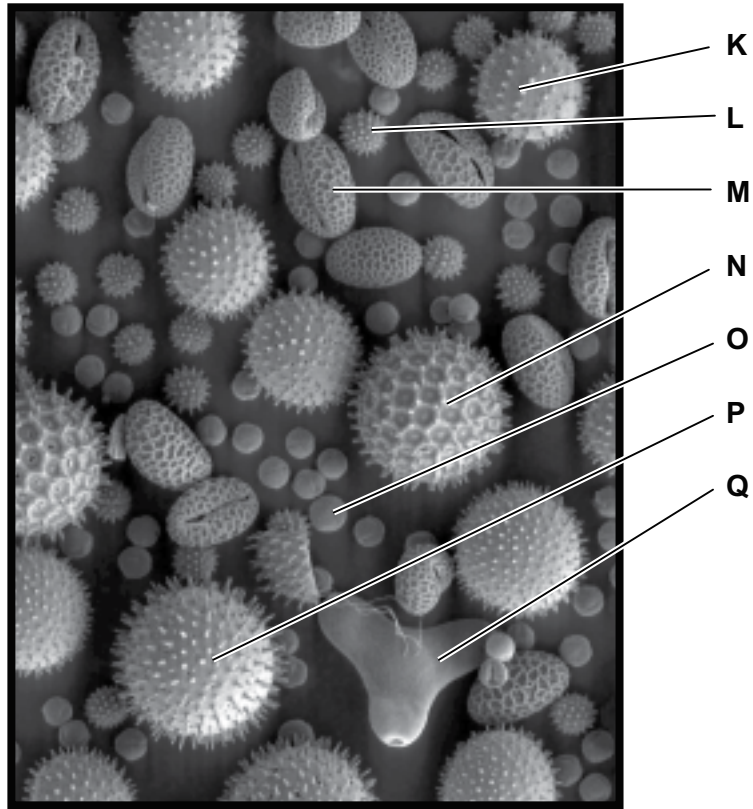

Fig. 7.2

State the letters of the pollen grains that come from insect-pollinated flowers.

..... [2]

[Total: 10]

8 Fig. 8.1 shows a field of sugar cane and the remains of the sugar cane after the harvest.



sugar cane



remains after harvest

Fig. 8.1

The sugars in sugar cane can be used to make ethanol biofuel.

- (a) (i) State the name of an organism that can be used to make ethanol biofuel from sugars.
..... [1]
- (ii) State the process that this organism uses to make ethanol biofuel from sugars.
..... [2]
- (b) A lot of heat is needed for the final stage of making the biofuel. This heat can be provided by burning fossil fuels.

Explain why it would be better to burn the remains of the sugar cane instead of burning a fossil fuel.

.....
.....
.....
..... [2]

[Total: 5]

9 Fig. 9.1 represents the carbon cycle.

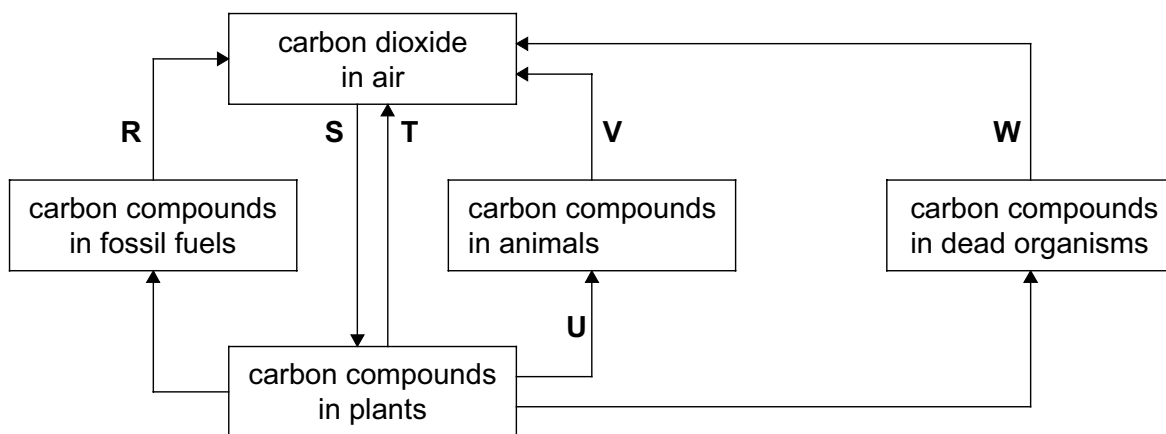

Fig. 9.1

(a) Use Fig. 9.1 to answer the following questions.

(i) Name the process labelled **U**.

..... [1]

(ii) Name a group of organisms that are responsible for the process labelled **W**.

..... [1]

(iii) List **two** letters that identify respiration.

..... [2]

(iv) State which letter identifies photosynthesis.

..... [1]

(b) State the word equation for aerobic respiration.

..... [2]

(c) Suggest reasons why the mean percentage of carbon dioxide in the atmosphere has increased during the last 100 years.

.....

 [3]

[Total: 10]

- 10 (a) Fig. 10.1 shows the concentration of alcohol in the blood of a person over a number of hours. Between 8pm and midnight the person had several alcoholic drinks while eating a meal.

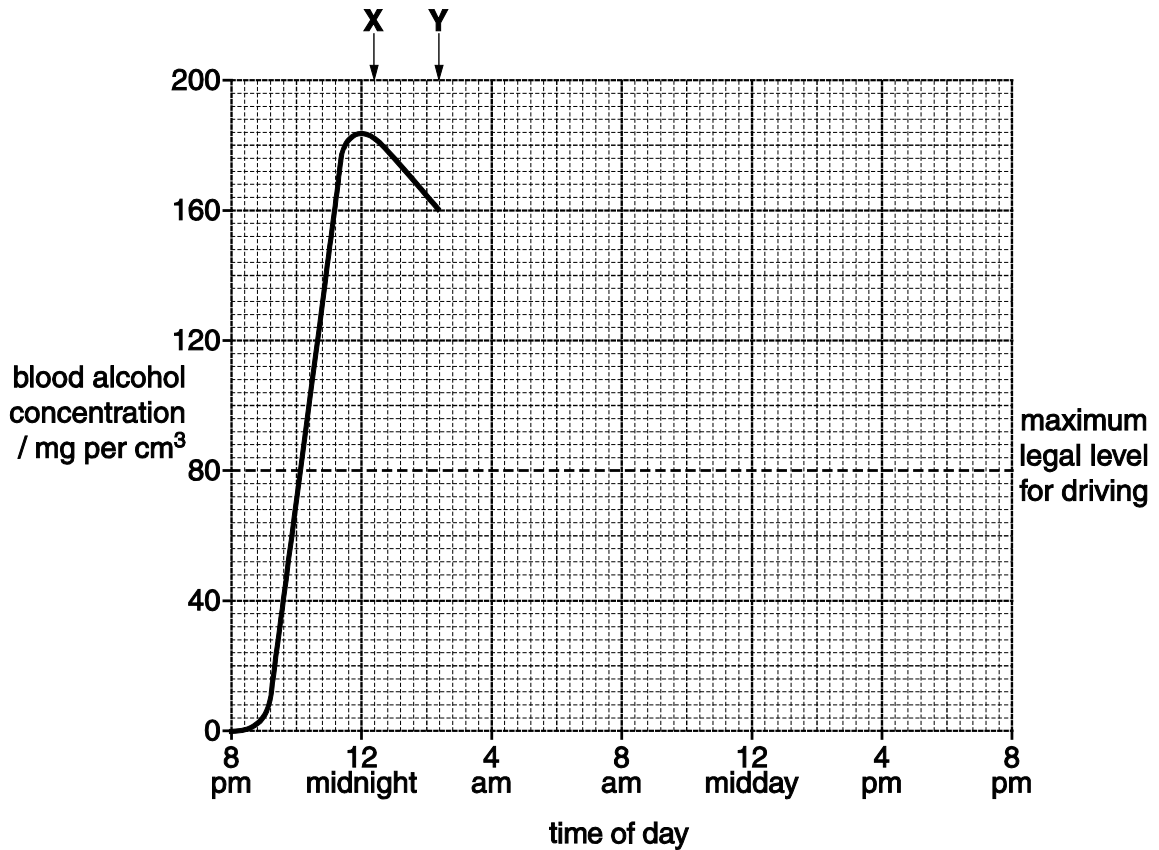

Fig. 10.1

- (i) The concentration of alcohol in this person's blood began to fall after midnight. State the organ that removes the alcohol from the blood.

..... [1]

- (ii) In some countries, it is illegal for a person to drive a vehicle with a blood alcohol concentration of more than 80 mg of alcohol per cm³ of blood.

Complete the graph to predict the earliest time, after midnight, at which this person would legally be able to drive a vehicle again.

You can assume that the alcohol concentration continues to fall at the same rate as between X and Y.

time [2]

(b) (i) Suggest why drinking alcohol makes driving a car more dangerous.

.....
..... [1]

(ii) State **two other** harmful effects of alcohol on the body.

1
2 [2]

[Total: 6]

11 Fig. 11.1 shows a white sweet pea flower and a red sweet pea flower.



Fig. 11.1

These colours in sweet pea are controlled by a single gene with two alleles.

(a) Define the term *allele*.

.....
 [1]

(b) A homozygous sweet pea with white flowers was crossed with a homozygous sweet pea with red flowers. All of the offspring had red flowers.

State which allele of this gene is dominant.

..... [1]

(c) Two heterozygous sweet pea plants with red flowers were crossed as shown below.

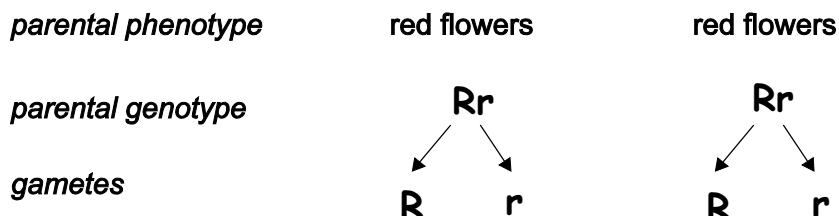

(i) Draw a Punnet square to show the genotypes that are produced in this cross.

[2]

(ii) State the phenotypic ratio produced in this cross.

..... [1]

[Total: 5]

Permission to reproduce items where third-party owned material protected by copyright is included has been sought and cleared where possible. Every reasonable effort has been made by the publisher (UCLES) to trace copyright holders, but if any items requiring clearance have unwittingly been included, the publisher will be pleased to make amends at the earliest possible opportunity.