



UNIVERSITY OF CAMBRIDGE INTERNATIONAL EXAMINATIONS
International General Certificate of Secondary Education

CANDIDATE
NAME

CENTRE
NUMBER

--	--	--	--	--

CANDIDATE
NUMBER

--	--	--	--

* 4 5 7 6 4 1 7 2 8 7 *

COMBINED SCIENCE

0653/61

Paper 6 Alternative to Practical

May/June 2010

1 hour

Candidates answer on the Question paper

No Additional Materials are required.

READ THESE INSTRUCTIONS FIRST

Write your Centre number, candidate number and name on all the work you hand in.

Write in dark blue or black pen.

You may use a soft pencil for any diagrams, graphs, tables or rough working.

Do not use staples, paper clips, highlighters, glue or correction fluid.

DO NOT WRITE IN ANY BARCODES.

Answer **all** questions.

At the end of the examination, fasten all your work securely together.

The number of marks is given in brackets [] at the end of each question or part question.

For Examiner's Use	
1	
2	
3	
4	
5	
6	
Total	

This document consists of **19** printed pages and **1** blank page.



1 One of the characteristics of living things is the ability to detect changes in their surroundings and respond to them. This is important for survival.

(a) A choice chamber was used to study the responses of woodlice (small invertebrates) to the intensity of light and the amount of moisture in their surroundings. The choice chamber is shown in Fig. 1.1.

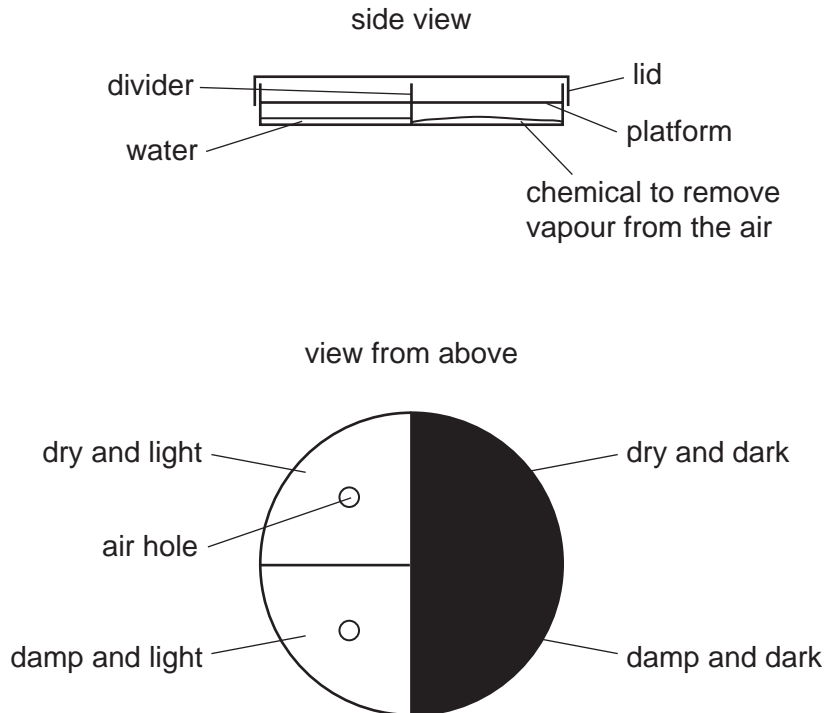

Fig. 1.1

- The divider separated the base of the chamber in half. One side was dry and the other side was damp.
- A platform for the woodlice was made from muslin (a type of net) and this covered the base.
- Half of the lid was covered with light-proof paper. The lid was placed so that four different conditions were produced. The conditions were:
 - dry and dark,
 - damp and dark,
 - dry and light,
 - damp and light.
- Ten woodlice were placed on the centre of the muslin and left for 15 minutes.
- After this time the number of woodlice in each area was counted.

The experiment was done three times. After each test the lid was removed and the number of woodlice in each area was counted. The platforms when viewed from above are shown in Fig. 1.2.

- (i) Count the number of woodlice in each area of the choice chamber and enter the numbers in Table 1.3. Test **A** has been done for you. [2]

For
Examiner's
Use

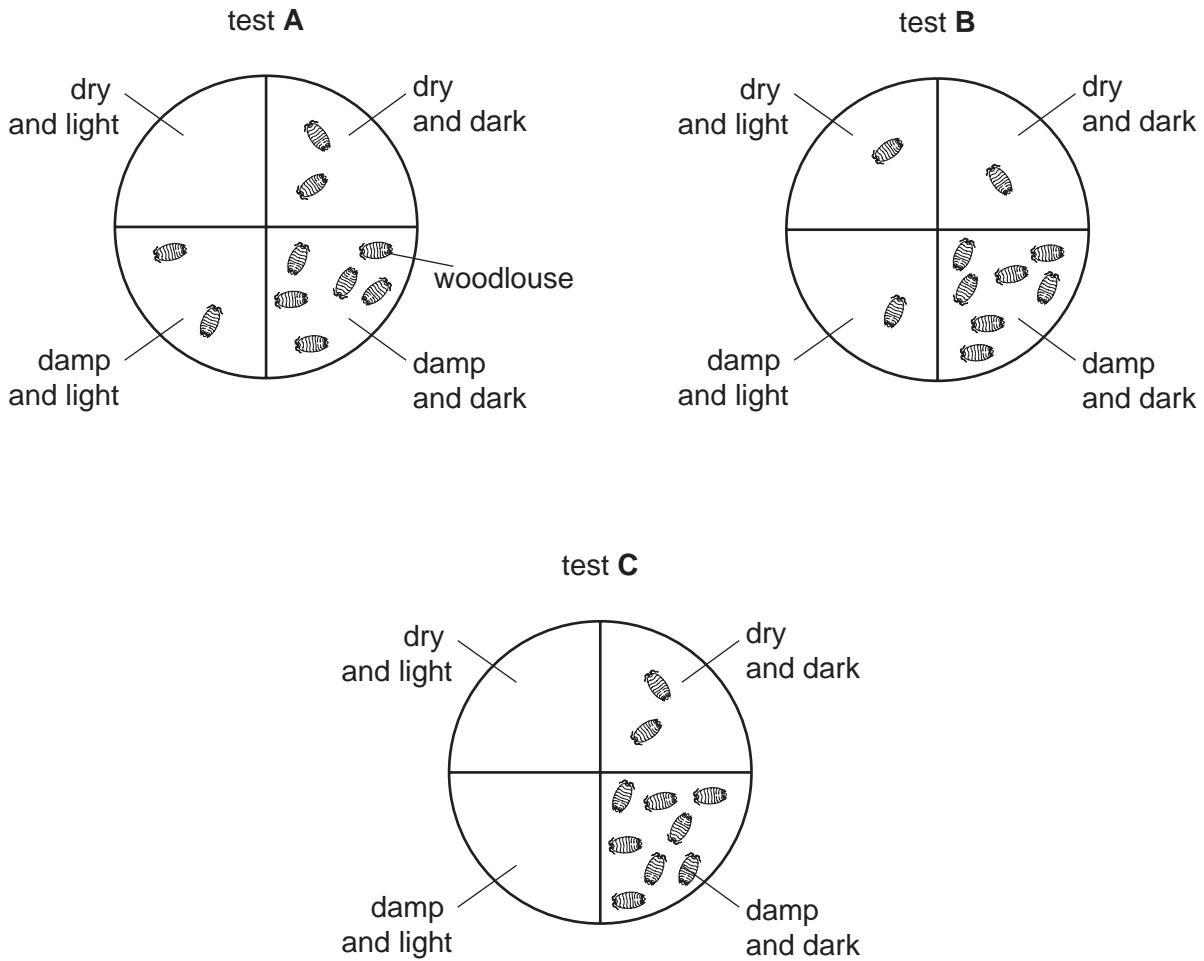

Fig. 1.2

Table 1.3

conditions in each area	number of woodlice counted			average number of woodlice
	test A	test B	test C	
dry and dark	2			
damp and dark	6			
damp and light	2			
dry and light	0			

- (ii) Calculate the average numbers of woodlice in each area and complete the last column of Table 1.3. [2]

(b) Draw a bar chart to show the average number of woodlice (vertical axis) found in each condition.

For
Examiner's
Use

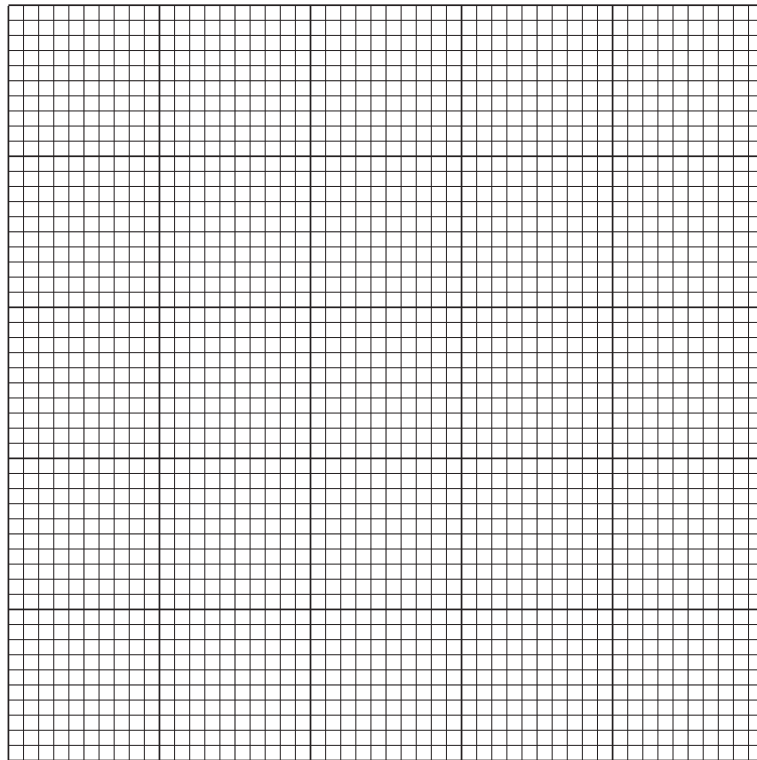

[3]

(c) (i) Which **two** external conditions did the woodlice prefer?

..... and [1]

(ii) Choose **one** of these conditions and suggest how this may help the woodlice to survive.

.....
.....
..... [2]

- 2 A student is investigating the acceleration of a falling mass due to the force of gravity. He is using a ticker-timer. This apparatus is shown in Fig. 2.1.

For
Examiner's
Use

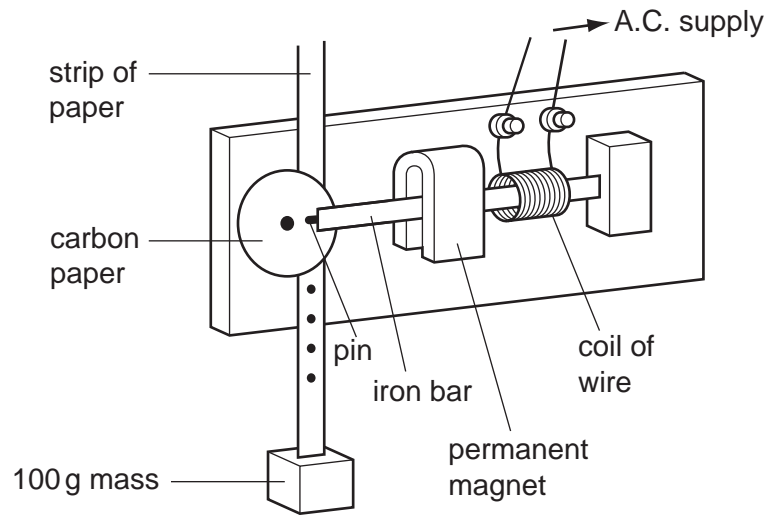

Fig. 2.1

The iron bar is fixed at one end. The bar passes between the poles of a permanent magnet. An alternating current passing through the coil causes the bar to vibrate 50 times per second. At the other end of the bar the pin hits the carbon paper disc making a mark on the paper strip each time the bar vibrates.

- (a) (i) Explain what is meant by an *alternating current*.

.....
..... [1]

- (ii) Explain why the alternating current makes the iron bar vibrate.

.....
.....
..... [2]

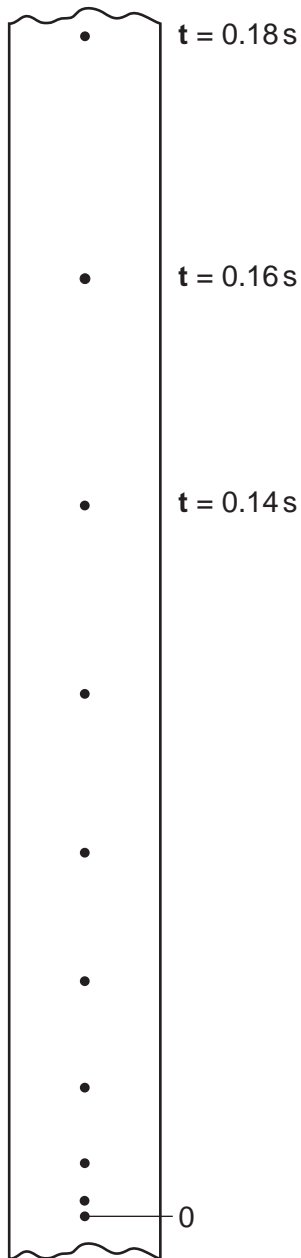

Fig. 2.2

Table 2.3

time/s	distance from point 0 / cm	distance from point 0 / m
0.00	0.0	0.000
0.02	0.2	0.002
0.04	0.7	0.007
0.06	1.7	0.017
0.08	3.1	0.031
0.10	4.8	0.048
0.12	6.9	0.069
0.14		
0.16		
0.18		

For
Examiner's
Use

A 100 g mass is fixed on the end of the strip of paper. The student allows the mass to fall. It pulls the paper through the ticker-timer as shown in Fig. 2.1. Marks are made on the paper strip.

Part of the paper strip is shown in Fig. 2.2. The student is measuring the distance of each mark from the start, point 0. He has recorded the first six distances in Table 2.3.

(b) (i) Using Fig. 2.2, measure the distances from point 0 to the dots at $t = 0.14$ s, 0.16 s, and 0.18 s, in centimetres, to the nearest millimetre. Record the distances in Table 2.3. [3]

(ii) Complete Table. 2.3 by converting these three distances from centimetres to metres. [1]

(iii) Use data from Table 2.3 to show that the mass and paper accelerated as they fell.

.....

 [1]

*For
Examiner's
Use*

(c) Calculate **g**, the acceleration due to gravity, by using data from Table 2.3 and the following equation.

$$\mathbf{g} = \frac{2 \times \text{distance of fall in metres}}{(\text{time of fall in seconds})^2}$$

g = m/s² [2]

- 3 The science teacher gives a student the apparatus shown in Fig. 3.1. She also gives her three solutions, **X**, **Y** and **Z** of different concentrations of the same acid.

For
Examiner's
Use

The student must find out which of the three acid solutions is the most concentrated.

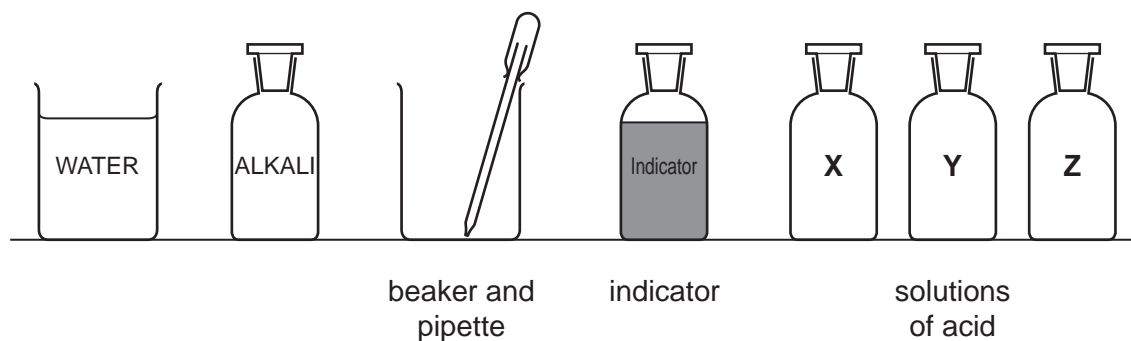

Fig. 3.1

- The student places 5 cm³ of the acid **X** in the beaker.
- She adds 1 drop of the indicator.
- She adds the alkali, 1 drop at a time, until the indicator changes colour.
- She records the number of drops of alkali added in Table 3.2.
- She repeats the experiment with the acid solutions **Y** and **Z**.

Table 3.2

acid solution	number of drops
X	22
Y	17
Z	8

Table 3.3 below shows the colour of the indicator at different levels of pH.

Table 3.3

colour of indicator	red	orange
pH of solution	5	9

- (a) State the colour of the indicator

in acid,

in alkali.

[1]

(b) (i) Which of the acid solutions, **X**, **Y** or **Z** is the most concentrated?

..... [1]

(ii) Explain your answer.

.....
..... [1]

(c) Suggest why the beaker of water is needed.

.....
..... [1]

(d) Name an alkali that can be used in this experiment.

..... [1]

The student wants to find out the name of the acid used in the experiment. She places 2 cm³ of solution **X** in a test-tube and adds aqueous silver nitrate. A white precipitate is formed.

(e) (i) Name the white precipitate.

..... [1]

(ii) Name the acid in solution **X**.

..... [1]

(f) Describe how you could use pieces of magnesium ribbon to find out which of the three solutions is the most concentrated.

.....
.....
.....
.....
..... [3]

- 4 A student did an experiment to find the density of salt solution. He floated a test-tube containing sand, in water and then in the salt solution. This is shown in Fig. 4.1.

For
Examiner's
Use

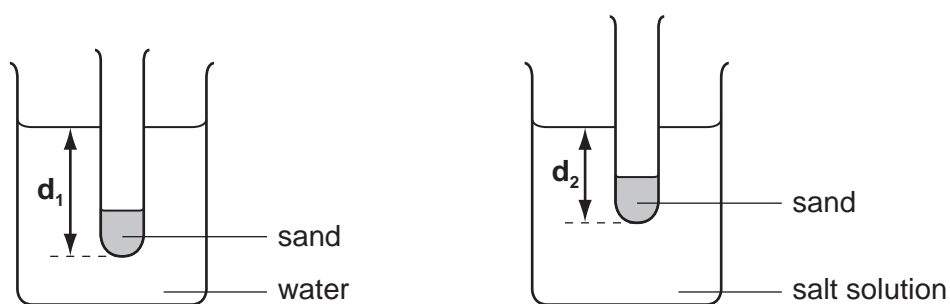

Fig. 4.1

- He placed dry sand in the test-tube and floated it in water. He measured the depth d_1 from the water surface to the bottom of the tube. He recorded this in the first row of Table 4.2, **experiment 1**.
- He placed the same tube in the salt solution and found the depth d_2 . He recorded this in the first row of Table 4.2.
- He emptied some of the sand out of the test-tube and found d_1 and d_2 again, **experiment 2**.
- He emptied out more of the sand and found another set of readings for d_1 and d_2 , **experiment 3**.

Table 4.2

experiment number	depth d_1 in water / millimetres	depth d_2 in salt solution / millimetres
1	104	86
2	85	70
3		

Fig. 4.3 shows the tube floating in water and in salt solution for **experiment 3**. The student has placed a ruler graduated in millimetres next to the tube.

For
Examiner's
Use

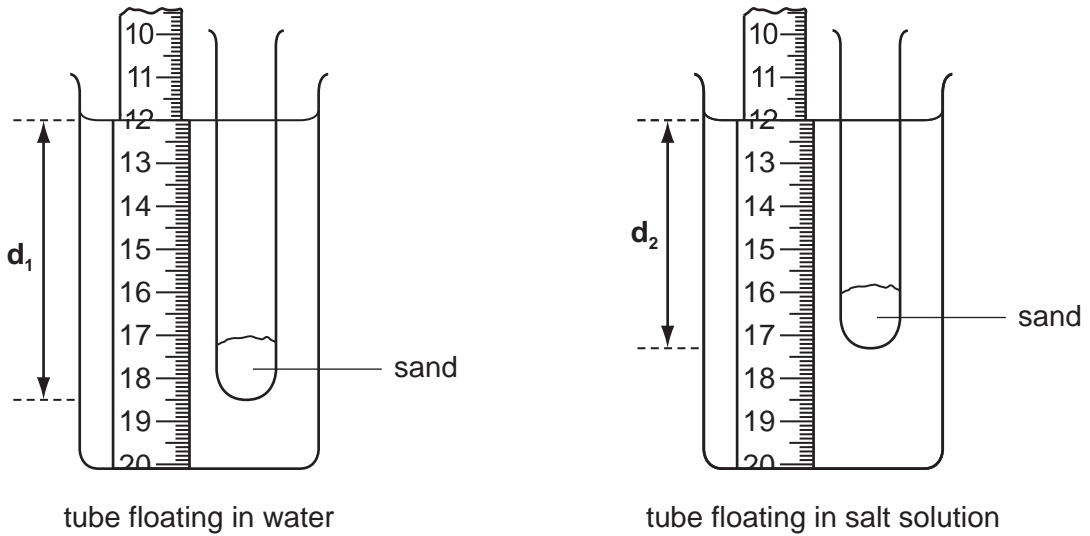

Fig. 4.3

- (a) (i) Briefly explain why the ruler appears larger when viewed through the side of the beaker.

.....
 [1]

- (ii) Use the scale of the ruler to calculate the depth d_1 for the tube floating in water.
 Record the value in Table 4.2.

depth d_1 = mm [2]

- (iii) Use the scale of the ruler to calculate the depth d_2 for the tube floating in salt solution.

Record the value in Table 4.2.

depth d_2 = mm [1]

- (b) On the grid below, plot the values for d_1 from Table 4.2 (vertical axis) against d_2 . Draw the best straight line and extend it to pass through the point (0,0).

For
Examiner's
Use

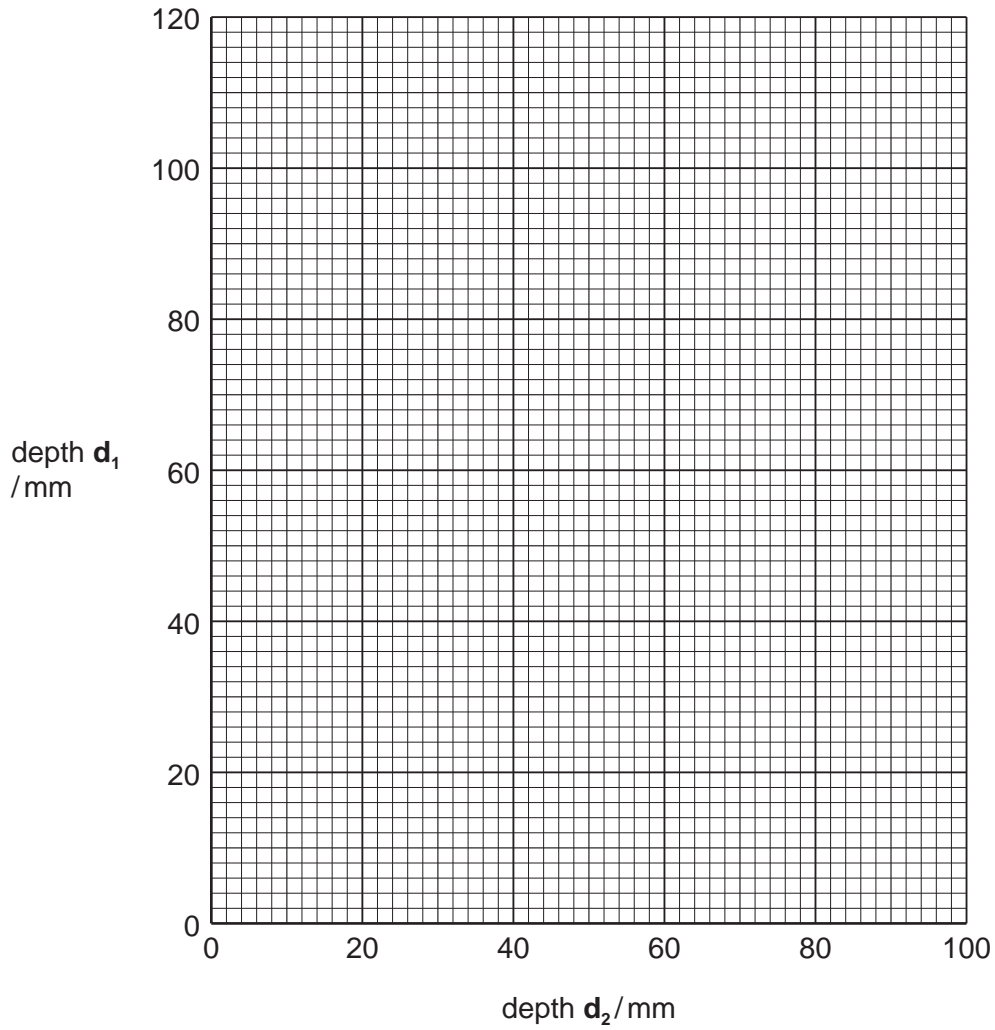

[2]

- (c) Calculate the gradient of the line, showing on your graph the values you use to do this. The gradient is numerically equal to the density of the salt solution in grams per cubic centimetre.

gradient = [2]

(d) Describe another method for finding the density of a liquid using a pipette or burette, a beaker and a balance.

*For
Examiner's
Use*

.....

.....

.....

.....

..... [2]

5 Some plants show differences between leaves found in sunny areas of the plant (sun leaves), and leaves found in shaded areas (shade leaves).

(a) A student was supplied with two leaves, labelled **sun leaf** and **shade leaf**. Drawings of the two leaves are shown in Fig. 5.1.

- (i) Measure the maximum length of each leaf, excluding the petiole (stalk). Write your measurements below each diagram.
- (ii)

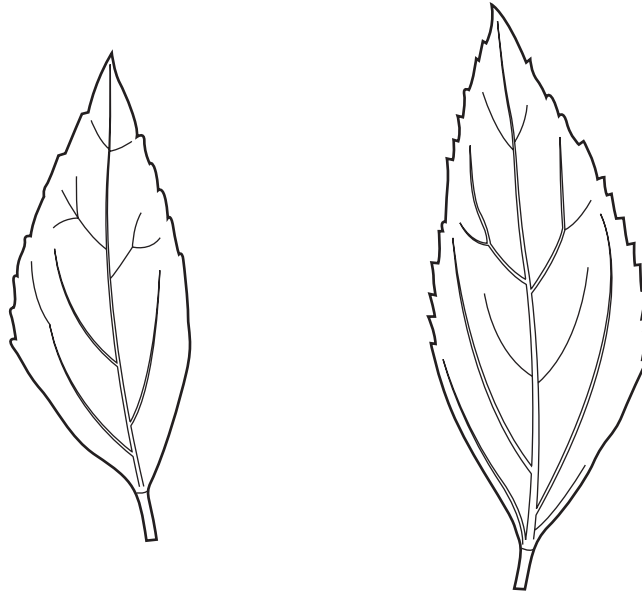

Fig. 5.1

sun leaf

shade leaf

length = mm

length = mm [2]

(ii) The leaves clearly have different areas.

One leaf has a larger surface than the other.

Suggest an advantage to the leaf with the larger area.

.....
.....
..... [1]

(b) The diagrams in Fig. 5.2 show cross-sections of a sun leaf and a shade leaf as viewed using a microscope.

For
Examiner's
Use

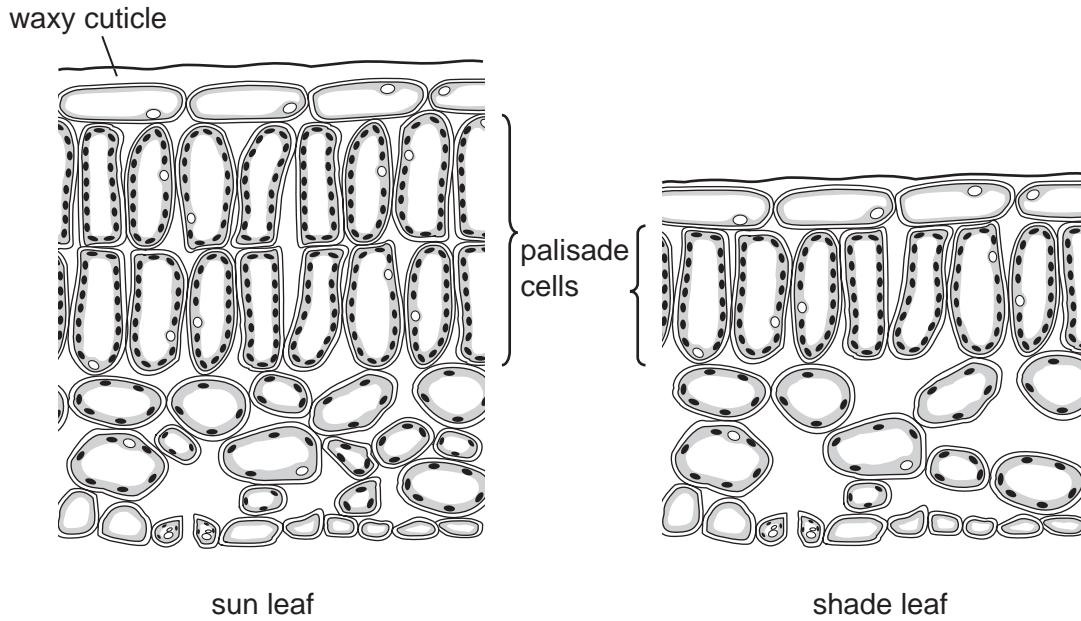

Fig. 5.2

Construct a table to compare these two diagrams. Include the following features; **thickness of leaf, number of palisade cells, size of air spaces.**

[4]

(c) Choose any **one** feature of the sun leaf in Fig. 5.2 and explain how this feature is a good adaptation for photosynthesis.

feature

explanation

..... [2]

- (d) The sun leaf usually has a thicker cuticle than the shade leaf. The cuticle is a waxy layer covering the leaf.

Suggest an advantage that this thicker cuticle gives to the sun leaf.

..... [1]

*For
Examiner's
Use*

- 6 The science teacher is showing the class an experiment. He makes carbon dioxide and converts it into carbon monoxide. Then he reacts the carbon monoxide with copper(II) oxide.

For
Examiner's
Use

Fig. 6.1 shows the apparatus.

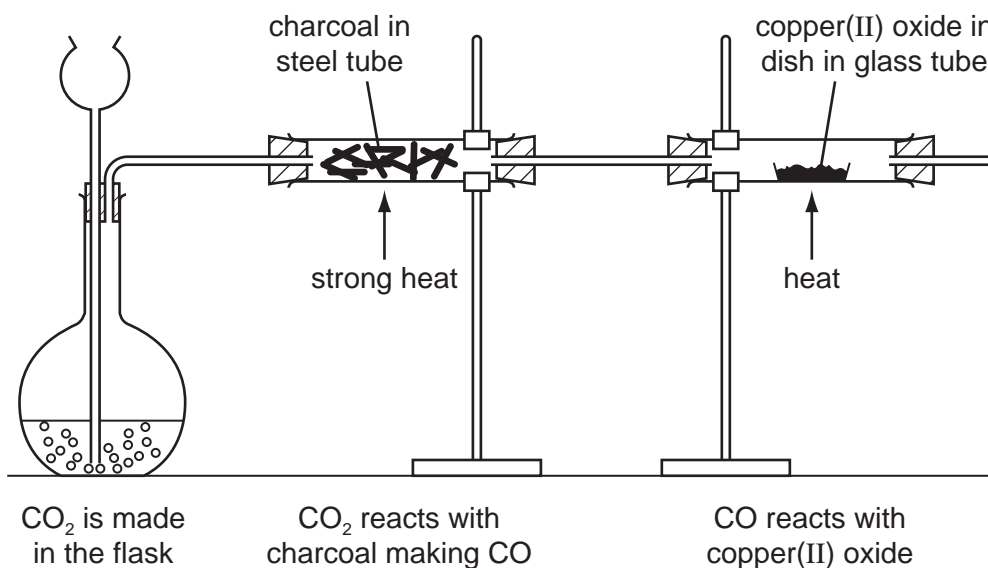

Fig. 6.1

- (a) Name a solid and a liquid that can be placed in the flask to make carbon dioxide.

solid

liquid

[2]

- (b) Complete the symbol equation to show the reaction in the steel tube.

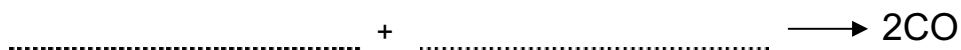

[1]

- (c) When the copper(II) oxide in the glass tube reacts with carbon monoxide it changes from black to reddish-brown. The teacher takes the dish out of the glass tube when it has cooled. He uses the apparatus shown in Fig. 6.2 to find out if the reddish-brown residue in the dish is a metal.

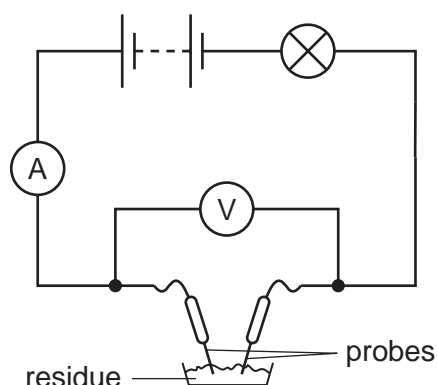

Fig. 6.2

Suggest **two** observations that the class can make, which show that the residue is a metal.

- 1
- 2 [2]

- (d) Before the experiment began, the teacher weighed the empty dish. Then he weighed it containing the copper(II) oxide. He recorded the masses in Table 6.3.

Table 6.3

mass of empty dish/g	mass of dish + copper(II) oxide/g	mass of dish + reddish-brown residue/g
35.9	43.9	

He weighs the dish containing the reddish-brown residue. Fig. 6.4 shows the balance window.

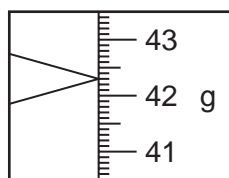

Fig. 6.4

- (i) Read the balance window. Record the mass of the dish containing the reddish-brown residue in Table 6.3. [1]

- (ii) Use the data from Table 6.3 to calculate the mass of the copper(II) oxide that the teacher placed in the dish.

mass of copper(II) oxide = g [1]

- (iii) Calculate the loss in mass of the copper(II) oxide when it reacted with carbon monoxide.

loss in mass = g [1]

The class decide that oxygen has been removed from the copper(II) oxide.

- (iv) What name is given to this process?

..... [1]

- (e) Suggest a reason why the teacher carried out this experiment in a fume cupboard instead of on the open laboratory bench.

.....
..... [1]

BLANK PAGE

Permission to reproduce items where third-party owned material protected by copyright is included has been sought and cleared where possible. Every reasonable effort has been made by the publisher (UCLES) to trace copyright holders, but if any items requiring clearance have unwittingly been included, the publisher will be pleased to make amends at the earliest possible opportunity.

University of Cambridge International Examinations is part of the Cambridge Assessment Group. Cambridge Assessment is the brand name of University of Cambridge Local Examinations Syndicate (UCLES), which is itself a department of the University of Cambridge.