

Centre Number	Candidate Number	Name
---------------	------------------	------

CAMBRIDGE INTERNATIONAL EXAMINATIONS
International General Certificate of Secondary Education

COMBINED SCIENCE

0653/01

Paper 1 Multiple Choice

October/November 2003

45 minutes

Additional Materials: Multiple Choice Answer Sheet
Soft clean eraser
Soft pencil (type B or HB is recommended)

READ THESE INSTRUCTIONS FIRST

Write in soft pencil.

Do not use staples, paper clips, highlighters, glue or correction fluid.

Write your name, Centre number and candidate number on the answer sheet in the spaces provided unless this has been done for you.

There are **forty** questions on this paper. Answer **all** questions. For each question there are four possible answers **A, B, C, and D**.

Choose the **one** you consider correct and record your choice in **soft pencil** on the separate answer sheet.

Read the instructions on the Answer Sheet very carefully.

Each correct answer will score one mark. A mark will not be deducted for a wrong answer.

Any rough working should be done in this booklet.

A copy of the Periodic Table is printed on page 20.

This document consists of **18** printed pages and **2** blank pages.

- 1 The diagram shows a section through a leaf on a hot and still day. The arrow shows the movement of water vapour.

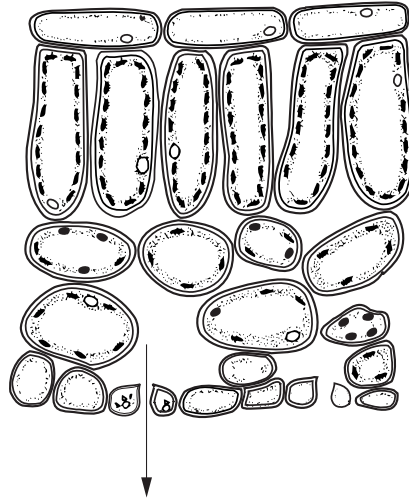

By which process is the water vapour moving out of the leaf?

- A absorption
 B diffusion
 C photosynthesis
 D secretion
- 2 Three test tubes, X, Y and Z each contain the same volume of dilute hydrogen peroxide solution. Equal volumes of raw potato are added to each tube but the potato is cut into different sized pieces.

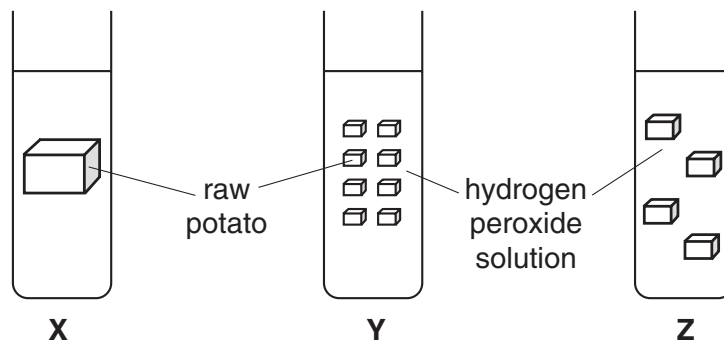

The rate of reaction is different in each tube.

What is the correct order?

	highest rate \longrightarrow lowest rate		
A	X	Y	Z
B	Y	Z	X
C	Z	X	Y
D	Z	Y	X

3 Which energy conversion occurs during photosynthesis?

- A chemical → light
- B light → chemical
- C heat → light
- D light → heat

4 A water plant is exposed to sunlight. After a short period of time bubbles are given off from the plant.

Which gas do the bubbles contain, and which process produces this gas?

	gas	process
A	carbon dioxide	photosynthesis
B	carbon dioxide	respiration
C	oxygen	photosynthesis
D	oxygen	respiration

5 Tests carried out on a sick student show that he is deficient in calcium.

What are his symptoms?

- A anaemia
- B bleeding gums
- C breathlessness
- D poor bone growth

6 Tests were performed on four samples of food. The results are shown in the table.

Which food contains protein **only**?

food sample	results of food tests		
	Benedict's test	biuret test	iodine test
A	blue	blue	blue/black
B	blue	purple	brown
C	red	blue	blue/black
D	red	purple	brown

7 The diagrams show alveoli from the lungs.

Which one will allow oxygen to diffuse into the blood most rapidly?

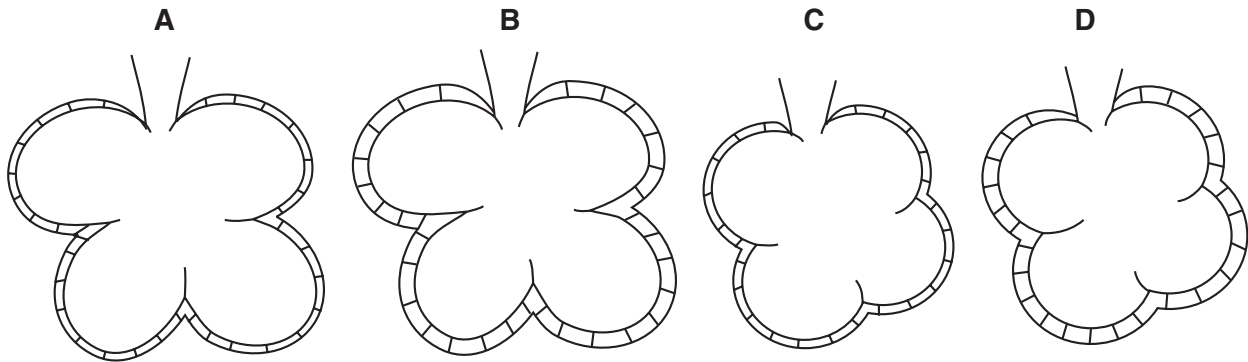

8 The diagram shows the blood supply to a group of muscle cells in the heart.

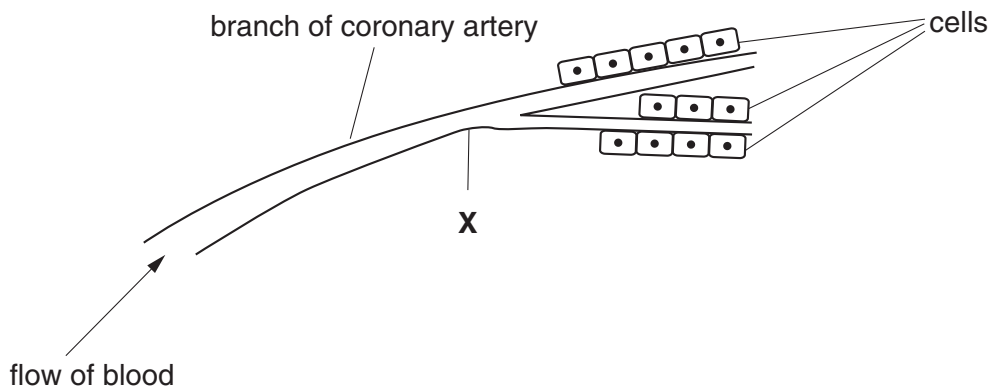

A blockage at point X causes a heart attack because a vital substance cannot reach the cells of the heart.

What is the vital substance?

- A amino acid
- B carbon dioxide
- C oxygen
- D urea

9 The drawing shows some blood, as it appears under the microscope.

Which part carries glucose to muscles?

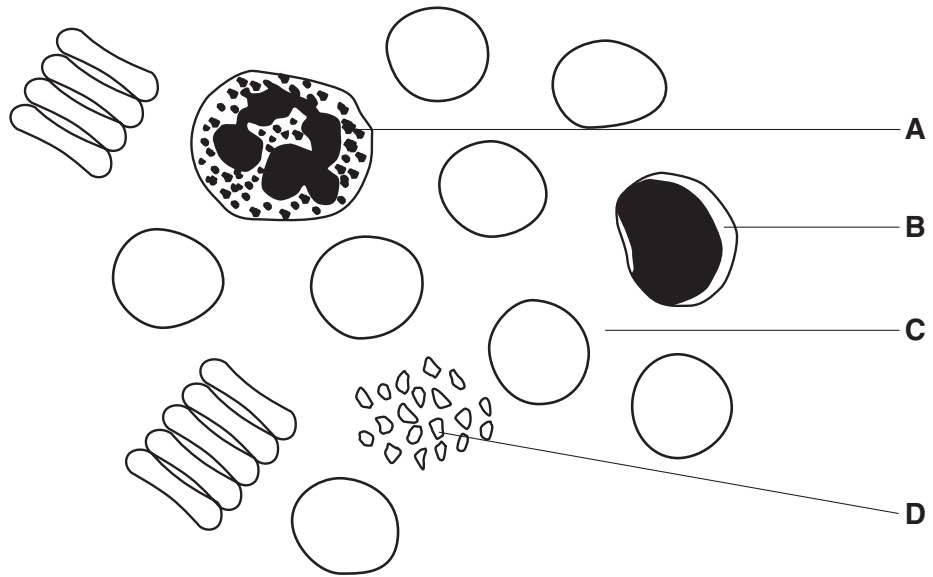

10 Water moves through the stomata of leaves during transpiration.

In which direction, and in which form, does it move?

	direction	form
A	into the leaf	liquid
B	into the leaf	vapour
C	out of the leaf	liquid
D	out of the leaf	vapour

11 In what order are these structures involved in responding to a stimulus?

- A** central nervous system → effector → receptor
- B** effector → central nervous system → receptor
- C** receptor → central nervous system → effector
- D** receptor → effector → central nervous system

12 During pollination, pollen grains are transferred from

- A anther to ovule.
- B anther to stigma.
- C stigma to anther.
- D stigma to ovule.

13 The diagram shows the human female reproductive organs.

Where is a fertilised egg normally implanted?

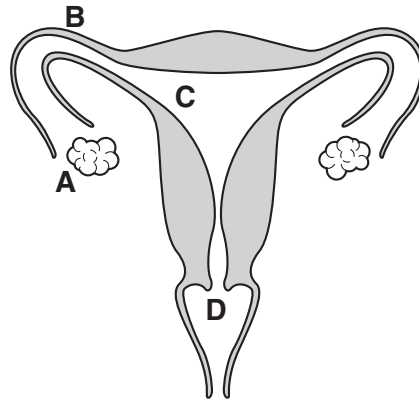

14 The diagram shows four processes, W, X, Y and Z that form part of the carbon cycle.

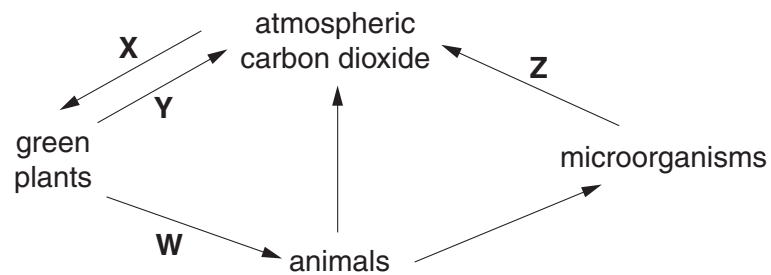

Which two processes represent respiration?

- A W and X
- B X and Y
- C Y and Z
- D Z and W

- 15 On heating iron and sulphur together, the mixture starts to glow. The glow then continues even when the heating is stopped.

In this reaction,**X**..... heat is given out and a new**Y**..... is formed.

What are words **X** and **Y**?

	X	Y
A	no	element
B	no	compound
C	some	element
D	some	compound

- 16 Which material is the main source of the molecules that are used to make most plastics?

- A** air
- B** coal
- C** limestone
- D** petroleum

- 17 The apparatus shown can be used to test a property of compound **R**.

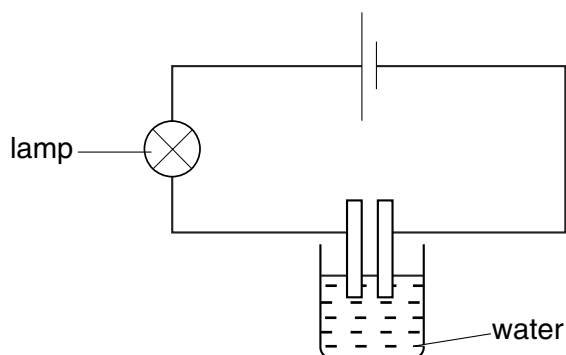

When compound **R** is dissolved in the water, the lamp lights.

Which statements about **R** are correct?

	type of bonding	elements in compound
A	covalent	a metal and a non-metal
B	covalent	non-metals only
C	ionic	a metal and a non-metal
D	ionic	non-metals only

18 The diagram shows a simplified outline of the Periodic Table.

Which letter shows the position of a metal with a low melting point?

A																	D		
																		C	
									B										

19 The burning of a hydrocarbon is shown by the equation.

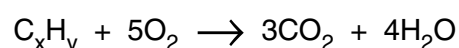

What is the formula of the hydrocarbon?

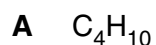

20 Which words correctly complete the following sentence?

Compared with iron, steel is**X**..... brittle and**Y**..... resistant to rusting.

	X	Y
A	less	less
B	less	more
C	more	less
D	more	more

21 Iron occurs in the ground as iron oxide. Gold occurs as the element.

Which statement explains this?

A Gold is more reactive than iron.

B Gold oxide is more reactive than iron oxide.

C Iron is more reactive than gold.

D Iron oxide is more reactive than gold oxide.

22 The diagrams show an experiment.

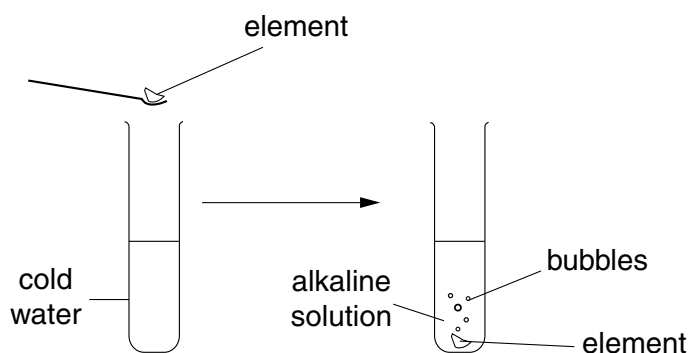

What could the element be?

- A calcium
- B carbon
- C iron
- D sulphur

23 A student wants to make magnesium nitrate by reacting magnesium oxide with an acid.

What is the formula of the acid he should use?

- A NH_3
- B NO_2
- C HNO_2
- D HNO_3

- 24 The diagram shows what happens when damp red litmus paper is placed into two different gases, **X** and **Y**.

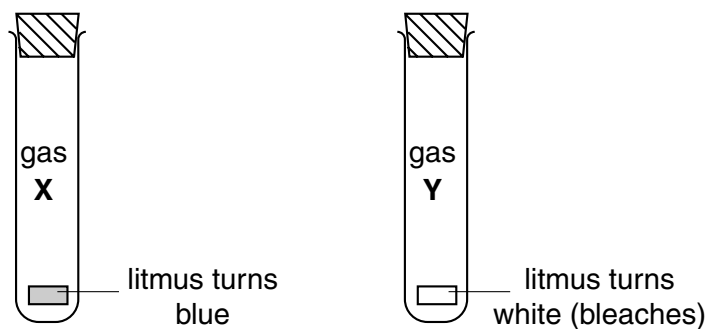

What are gases **X** and **Y**?

	X	Y
A	ammonia	carbon dioxide
B	ammonia	chlorine
C	chlorine	ammonia
D	chlorine	carbon dioxide

- 25 The diagram shows wood burning.

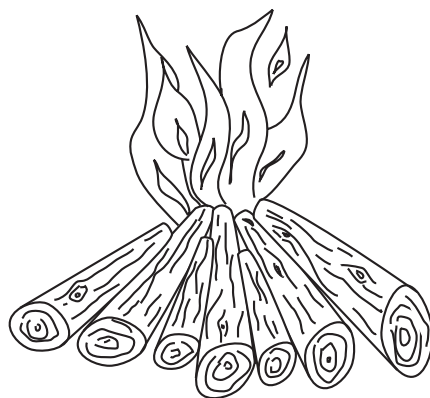

Which description of wood burning is correct?

- A** Both oxidation and reduction occur.
- B** Only decomposition occurs.
- C** Only oxidation occurs.
- D** Only reduction occurs.

26 A solution is tested for the presence of cations.

test	result
adding an excess of aqueous ammonia	green precipitate

Which cation is present?

- A Cu^{2+}
- B Fe^{2+}
- C Fe^{3+}
- D Zn^{2+}

27 When substance **X** burns, two products form.

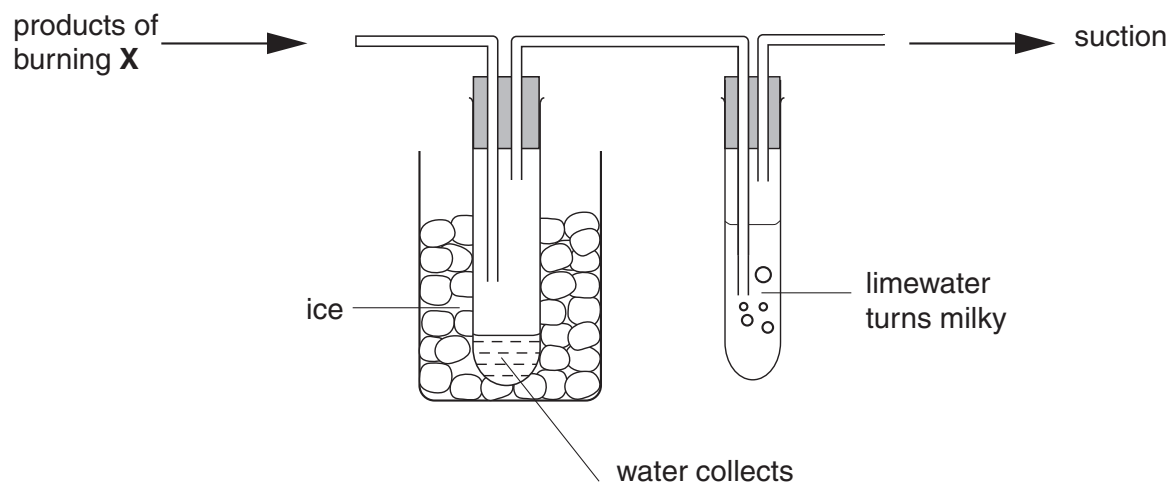

What is **X**?

- A carbon monoxide, CO
- B ethane, C_2H_6
- C hydrogen, H_2
- D sulphur, S

- 28 Which of the following is **not** necessary when using a measuring cylinder to measure the volume of a quantity of water?
- A making sure that the measuring cylinder is vertical
 - B making sure that your eye is level with the liquid surface
 - C reading the bottom of the meniscus
 - D using the largest measuring cylinder possible
- 29 Five telegraph poles are positioned at equal distances along the side of a road.

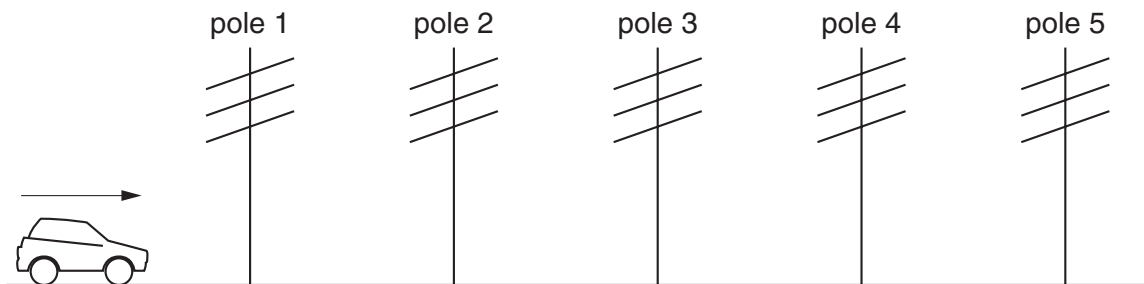

A car accelerates until it is level with pole 4. The car then continues along the road at a steady speed. The times taken to travel between one pole and the next are measured.

Which time is the greatest?

The time between

- A pole 1 and pole 2.
 - B pole 2 and pole 3.
 - C pole 3 and pole 4.
 - D pole 4 and pole 5.
- 30 A student tries to find the density of a metal block. First he measures the weight with a forcemeter (spring balance). Next he measures the sides of the block using a rule, in order to calculate the volume of the block. Finally he divides the weight by the volume to find the density.

The student has made a mistake.

Why does his method **not** give the density?

- A Density is volume divided by weight.
- B He should have measured the surface area, not the volume.
- C He should have used the mass in his calculation, not the weight.
- D Weight is not measured with a forcemeter (spring balance).

- 31 A tidal power station is made by building a barrage across the mouth of a river. At high tide the sea water is trapped behind the barrage.

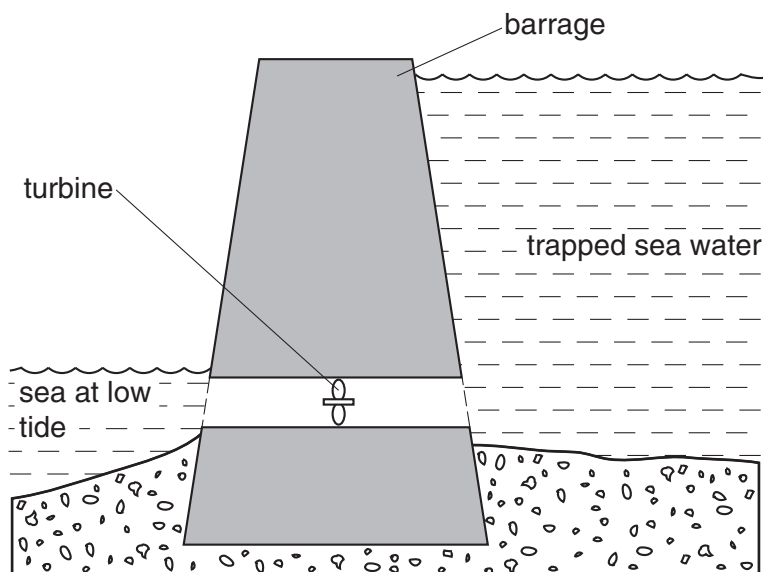

At low tide the water is allowed to flow back into the sea through a turbine.

What is the useful energy change in a tidal power station?

- A electrical energy \rightarrow energy of position (potential)
 - B electrical energy \rightarrow energy of motion (kinetic)
 - C energy of motion (kinetic) \rightarrow energy of position (potential)
 - D energy of position (potential) \rightarrow electrical energy
- 32 There is a vacuum between the double walls of a vacuum flask.

Which types of heat transfer are reduced by the vacuum?

- A conduction and convection
- B conduction and radiation
- C convection and radiation
- D conduction, convection and radiation

33 Waves travel more slowly on the surface of water when the water is shallow.

A person drops a stone into a pool at **X**. The diagram shows the first wavefront on the surface of the pool.

Which region of the pool is likely to be most shallow?

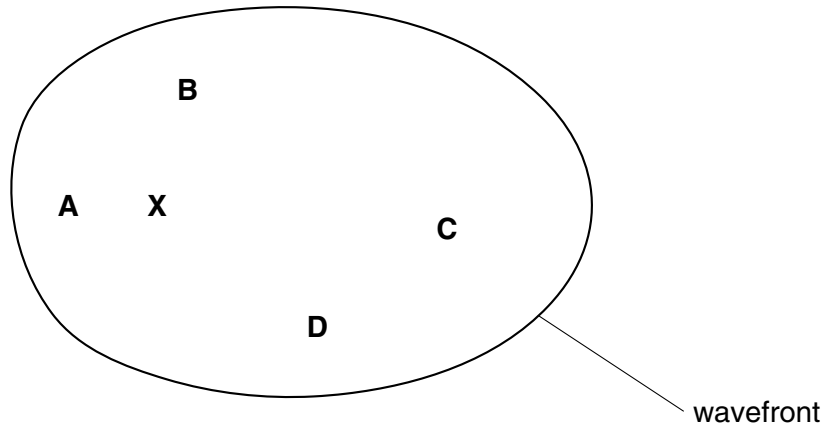

34 Which diagram shows the correct order of the waves in the electromagnetic spectrum?

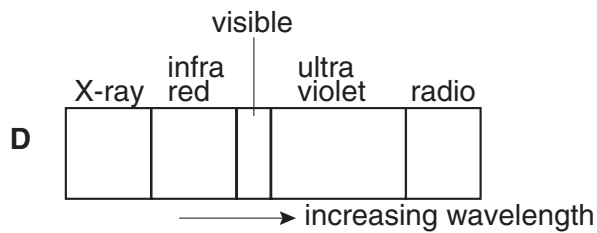
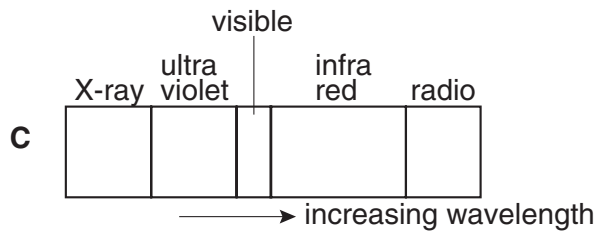
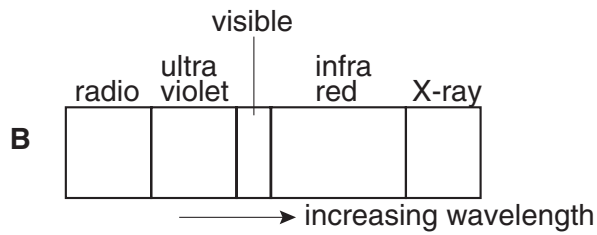
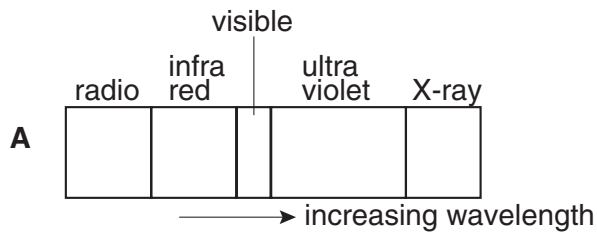

- 35 Astronaut 1 uses a hammer to mend a satellite in space. Astronaut 2 is nearby. There is no atmosphere in space.

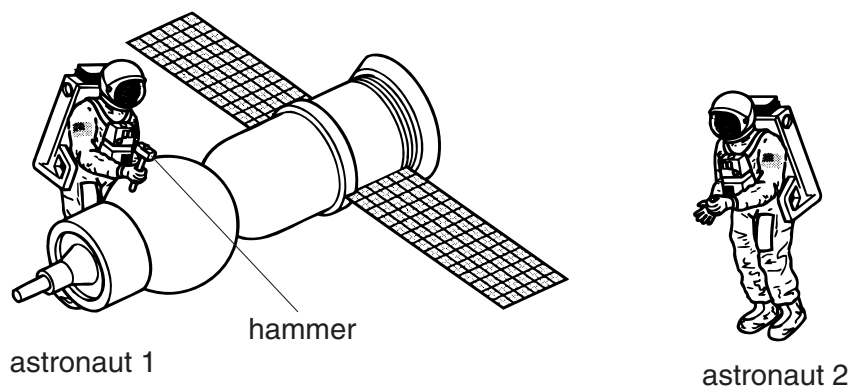

Compared with the sound heard if they were working on Earth, what does astronaut 2 hear?

- A no sound at all
 - B a quieter sound
 - C a sound of the same loudness
 - D a louder sound
- 36 A student wants to find the resistance of resistor R using a voltmeter and an ammeter.

Which circuit should the student use?

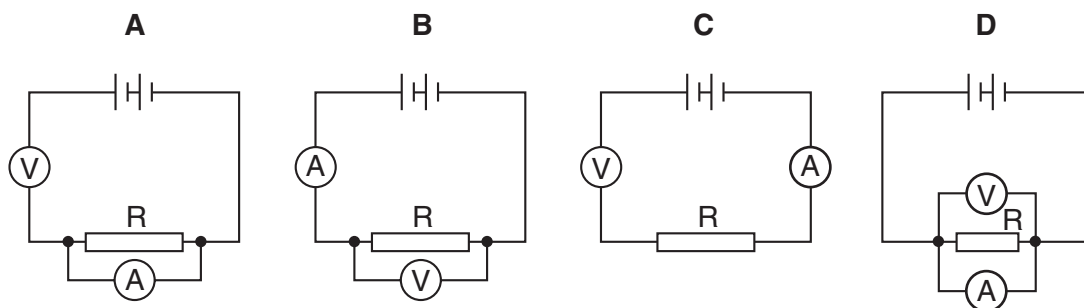

- 37 Four students are asked to draw a circuit showing three lamps working in parallel, a cell, and a switch that controls all three lamps.

Which student is correct?

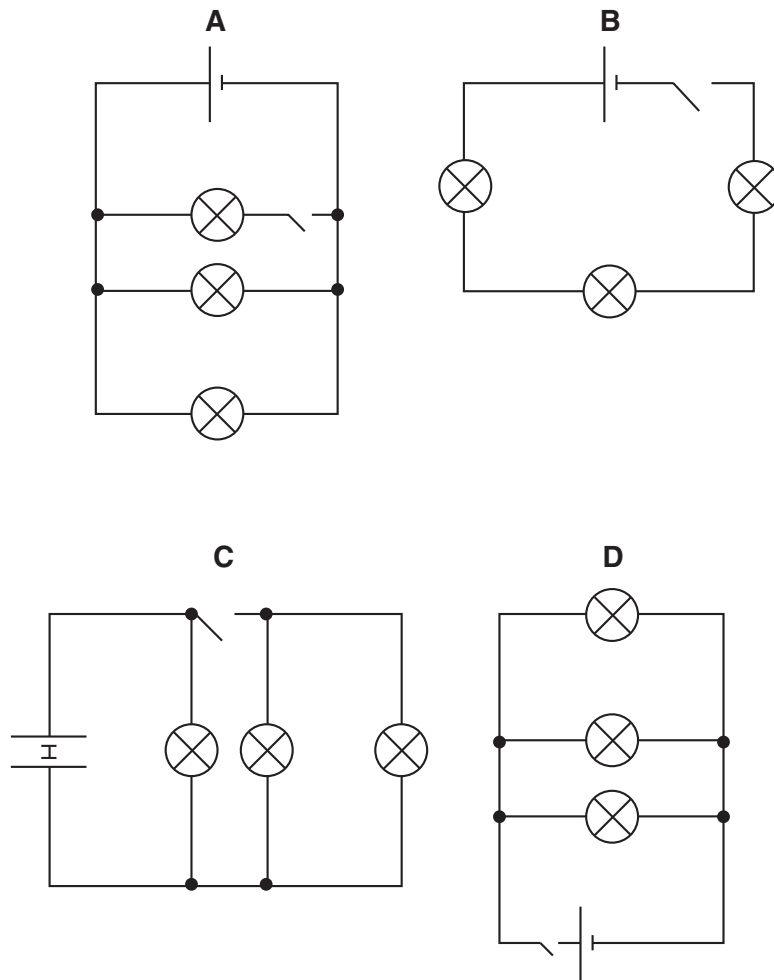

- 38 A $3.0\ \Omega$ lamp and a $6.0\ \Omega$ lamp are connected in series.

What is the total resistance of the combination?

- A $0.5\ \Omega$
- B $2.0\ \Omega$
- C $9.0\ \Omega$
- D $18.0\ \Omega$

39 How is electricity transmitted over large distances and why is it transmitted in this way?

	how	why
A	at high voltage	for safety
B	at high voltage	to reduce energy loss
C	at low voltage	for safety
D	at low voltage	to reduce energy loss

40 Which line in the table describes the nature of an α -particle and a γ -ray?

	α -particle	γ -ray
A	helium nucleus	electromagnetic radiation
B	helium nucleus	electron
C	proton	electromagnetic radiation
D	proton	electron

BLANK PAGE

DATA SHEET

The Periodic Table of the Elements

		Group										
I	II	III	IV	V	VI	VII	O					
7 Li Lithium 3	9 Be Beryllium 4	<div style="display: flex; justify-content: space-around; align-items: center;"> <div style="border: 1px solid black; padding: 2px;">1 H Hydrogen 1</div> </div>										4 He Helium 2
23 Na Sodium 11	24 Mg Magnesium 12											11 B Boron 5
39 K Potassium 19	40 Ca Calcium 20	27 Al Aluminium 13	28 Si Silicon 14	31 P Phosphorus 15	32 S Sulphur 16	35.5 Cl Chlorine 17	40 Ar Argon 18					
85 Rb Rubidium 37	88 Sr Strontium 38	59 Co Cobalt 27	55 Mn Manganese 25	59 Ni Nickel 28	64 Cu Copper 29	65 Zn Zinc 30	84 Kr Krypton 36					
133 Cs Caesium 55	137 Ba Barium 56	70 Ga Gallium 31	73 Ge Germanium 32	75 As Arsenic 33	79 Se Selenium 34	80 Br Bromine 35	131 Xe Xenon 54					
226 Ra Radium 88	227 Ac Actinium 89	77 Ir Iridium 77	75 Re Rhenium 75	78 Pt Platinum 78	79 Au Gold 79	80 Hg Mercury 80	86 Rn Radon 86					
*58-71 Lanthanoid series †90-103 Actinoid series		140 Ce Cerium 58	141 Pr Praseodymium 59	150 Sm Samarium 62	152 Eu Europium 63	157 Gd Gadolinium 64	162 Dy Dysprosium 66	165 Ho Holmium 67	167 Er Erbium 68	169 Tm Thulium 69	173 Yb Ytterbium 70	175 Lu Lutetium 71
		232 Th Thorium 90	238 U Uranium 92	94 Pu Plutonium 94	95 Am Americium 95	96 Cm Curium 96	97 Bk Berkelium 97	98 Cf Californium 98	99 Es Einsteinium 99	100 Fm Fermium 100	101 Md Mendelevium 101	102 No Nobelium 102

Key

a	X
b	

a = relative atomic mass
 X = atomic symbol
 b = proton (atomic) number

The volume of one mole of any gas is 24 dm³ at room temperature and pressure (r.t.p.).