

UNIVERSITY OF CAMBRIDGE INTERNATIONAL EXAMINATIONS
International General Certificate of Secondary Education

COMBINED SCIENCE

0653/01

Paper 1 Multiple Choice

October/November 2005

45 minutes

Additional Materials: Multiple Choice Answer Sheet
Soft clean eraser
Soft pencil (type B or HB is recommended)

READ THESE INSTRUCTIONS FIRST

Write in soft pencil.

Do not use staples, paper clips, highlighters, glue or correction fluid.

Write your name, Centre number and candidate number on the answer sheet in the spaces provided unless this has been done for you.

There are **forty** questions on this paper. Answer **all** questions.

For each question there are four possible answers **A, B, C** and **D**. Choose the **one** you consider correct and record your choice in **soft pencil** on the separate answer sheet.

Read the instructions on the answer sheet very carefully.

Each correct answer will score one mark. A mark will not be deducted for a wrong answer.

Any rough working should be done in this booklet.

A copy of the Periodic Table is printed on page 20.

This document consists of **19** printed pages and **1** blank page.



1 Which pair of features is found in plant cells but **not** in animal cells?

A	cell membrane	cell sap
B	cell sap	cell wall
C	cell wall	nucleus
D	nucleus	cell membrane

2 Which part of a plant cell is partially permeable?

- A** cell membrane
- B** cell wall
- C** chloroplast
- D** nucleus

3 The diagram shows how the activity of an enzyme varies with temperature.

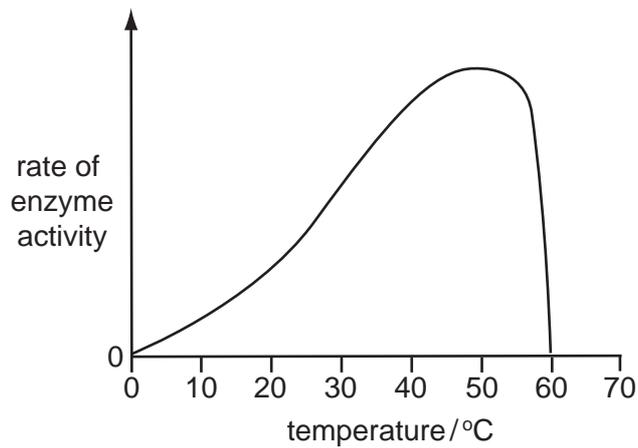

At which temperature is this enzyme completely denatured?

- A** 0°C
- B** 40°C
- C** 50°C
- D** 60°C

- 4 The drawing shows a plant in a container of water. There is a layer of oil on top of the water that stops the water evaporating. The apparatus weighs 300 g.

After two hours it weighs 296 g.

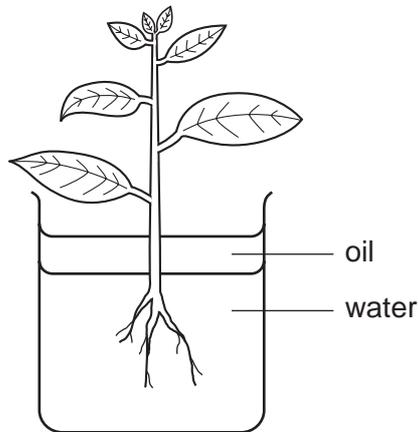

What is the rate of transpiration?

- A 150 g water/hour
 B 148 g water/hour
 C 4 g water/hour
 D 2 g water/hour
- 5 Which diagram represents the digestion of food molecules in the alimentary canal?

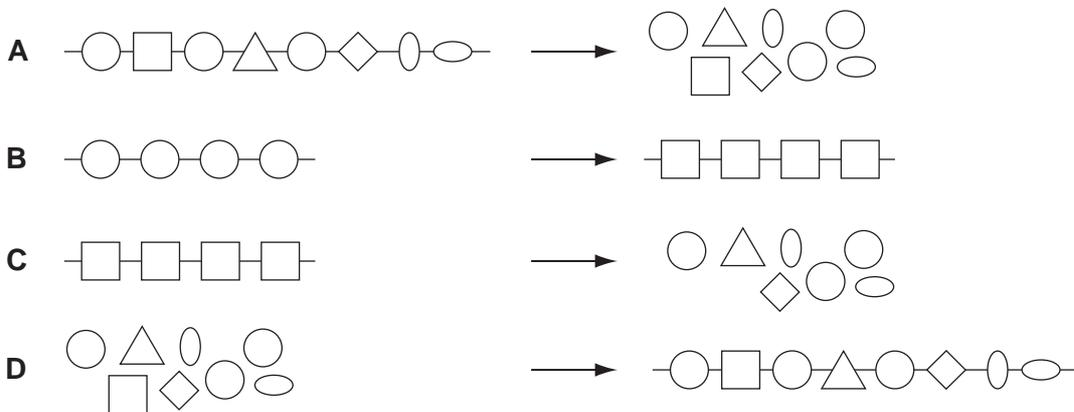

- 6 Which structures in the human breathing system contain goblet cells and cilia?
- A alveoli and bronchi
 B alveoli and pleural membranes
 C bronchi and trachea
 D pleural membranes and trachea

7 The diagram shows a section through a human heart.

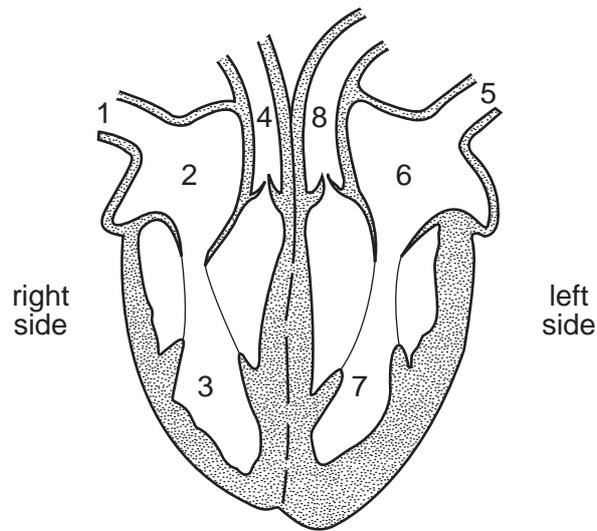

In which order does oxygenated blood pass through the heart?

- A 1 → 2 → 3 → 4
- B 4 → 3 → 2 → 1
- C 5 → 6 → 7 → 8
- D 8 → 7 → 6 → 5

8 What causes the signals passing along the nerves to slow down?

- A drinking alcohol
- B eating fat
- C running
- D smoking

9 The diagram shows a section through a flower.

Where does fertilisation occur?

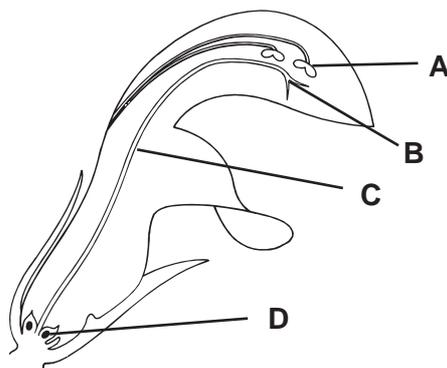

10 The diagram shows the human female reproductive system.

If a woman uses an IUD (intra-uterine device) as a contraceptive, where would it be placed?

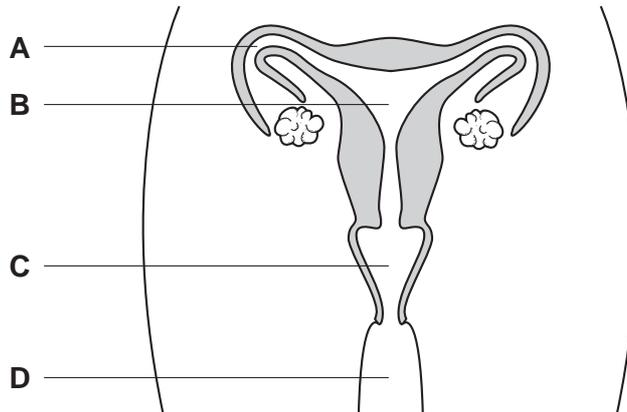

11 The diagram shows a section through a leaf.

During photosynthesis, where would the greatest conversion of light energy to chemical energy take place?

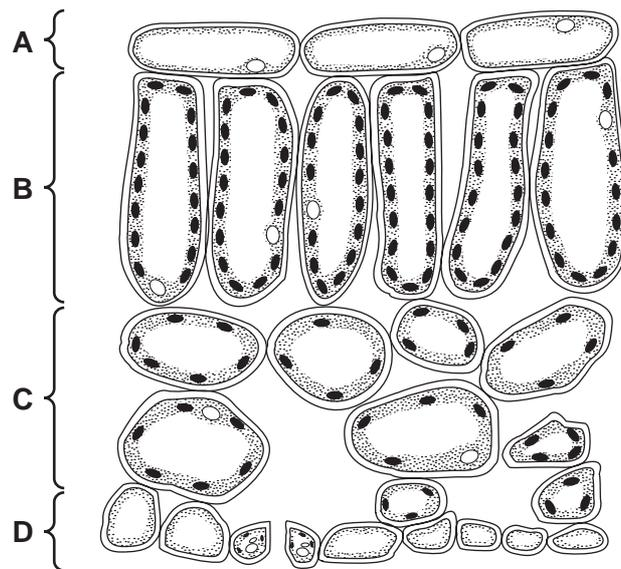

12 What can cause animals of the same species to vary?

	genes	environment
A	✓	✓
B	✓	x
C	x	✓
D	x	x

13 The diagram represents a food chain found in the sea.

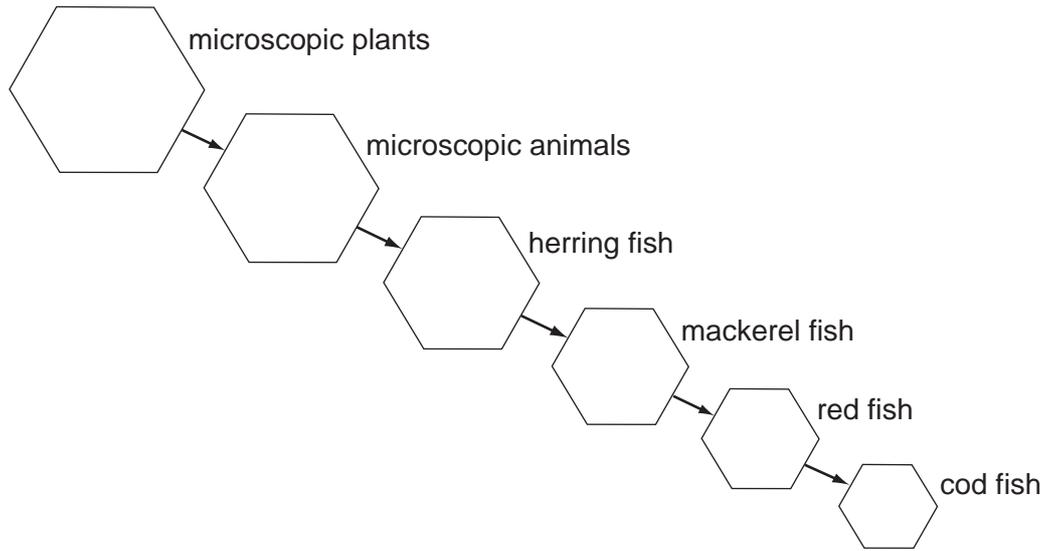

How many consumer levels are there?

- A** 1 **B** 4 **C** 5 **D** 6

14 Which fact about crude oil shows that it is a mixture?

- A** Crude oil can be burned as a fuel.
- B** Crude oil can be separated into fractions by distillation.
- C** Crude oil is a fossil fuel formed over millions of years.
- D** Crude oil is a thick, black liquid.

15 Which diagrams show the bonding in the molecules of carbon dioxide and ethene?

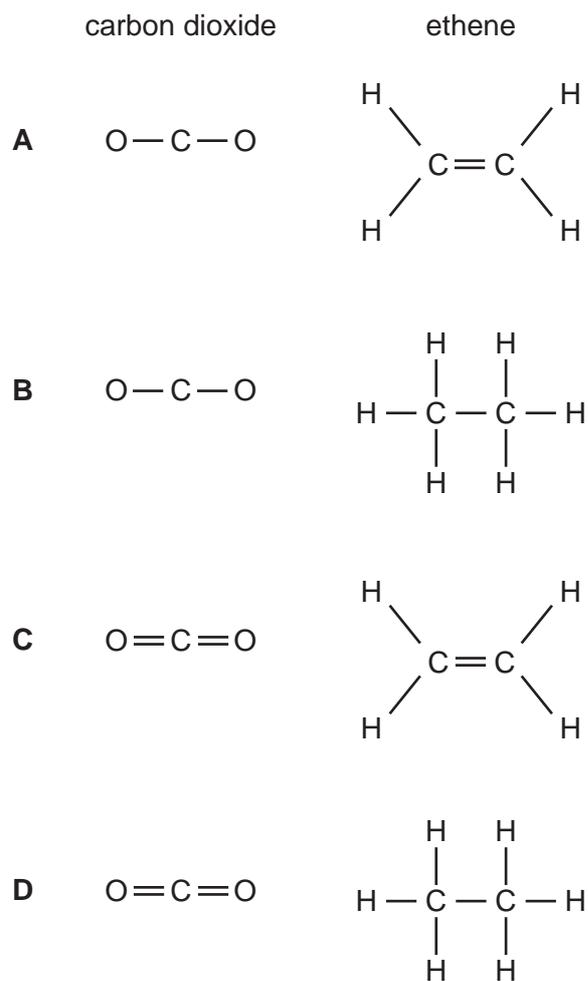

16 A solid is ionic.

Which property confirms this fact?

- A** its behaviour as an electrolyte
- B** its melting point
- C** its solubility in water
- D** the shape of its crystals

- 17 The diagram shows a solid element dropped into a bowl of water. The element catches fire and burns with a lilac flame.

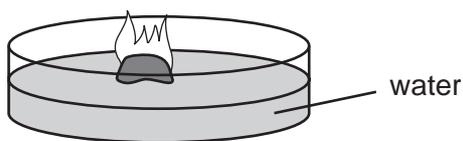

What is the element?

- A aluminium
 - B magnesium
 - C potassium
 - D sodium
- 18 Element X has a high melting point and forms a green chloride.

Where in the Periodic Table is X most likely to be found?

- A Group O
 - B Group I
 - C Group VII
 - D Transition elements
- 19 The diagram shows a lorry delivering a large container of a corrosive chemical to a factory.



Which metals are used for the lorry and for the container?

	lorry	container
A	aluminium	stainless steel
B	mild steel	mild steel
C	mild steel	stainless steel
D	stainless steel	mild steel

20 Which pie chart correctly shows the proportions of gases in the air?

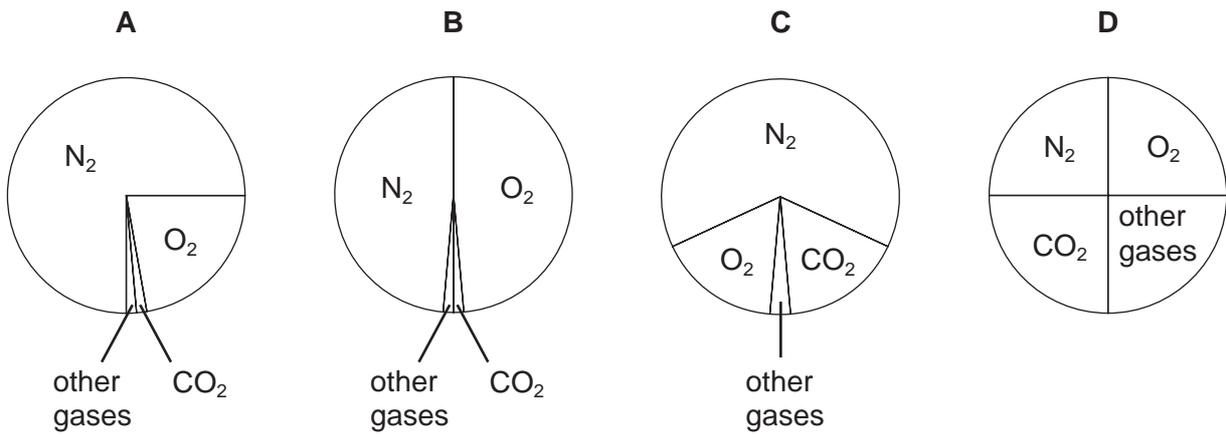

21 The diagram shows an experiment on combustion.

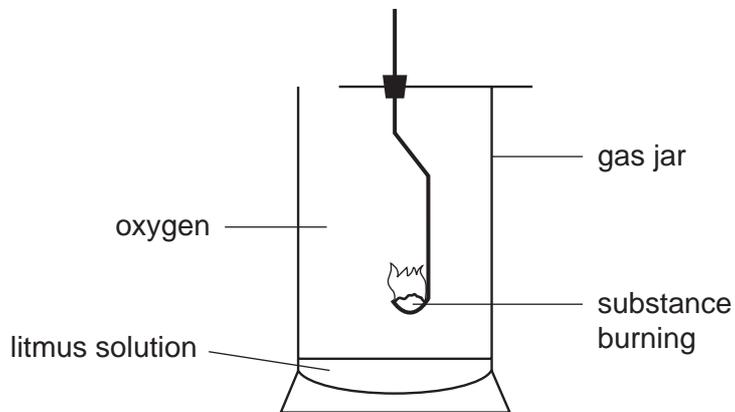

The litmus solution turns red.

Which substance is burning?

- A copper
- B magnesium
- C sulphur
- D zinc

22 The diagrams show the result of adding a powdered metal to dilute sulphuric acid.

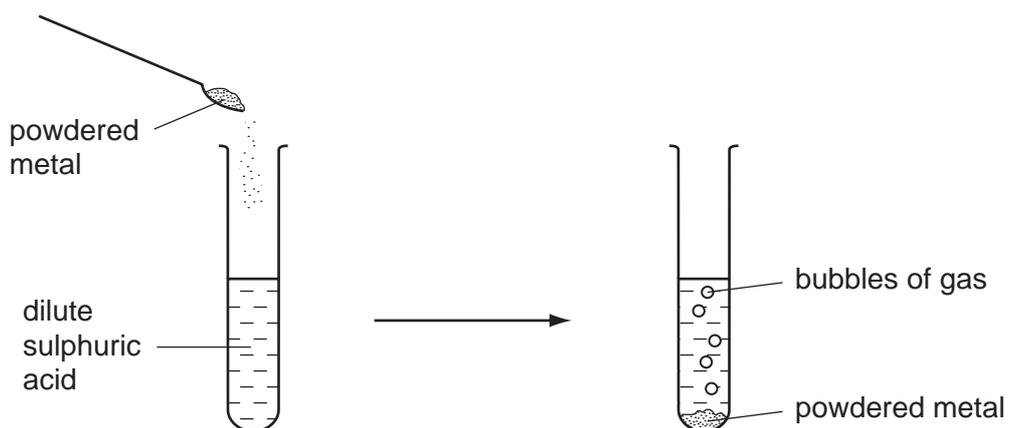

Which of the metals copper, magnesium and zinc react in this way?

- A copper only
 - B copper and magnesium only
 - C magnesium and zinc only
 - D zinc only
- 23 Which of the reactions shown is a thermal decomposition?
- A calcium carbonate \rightarrow calcium oxide + carbon dioxide
 - B methane + air \rightarrow carbon dioxide + water
 - C sodium carbonate + hydrochloric acid \rightarrow sodium chloride + water + carbon dioxide
 - D sodium hydroxide + hydrochloric acid \rightarrow sodium chloride + water

24 The diagram shows the results of three experiments.

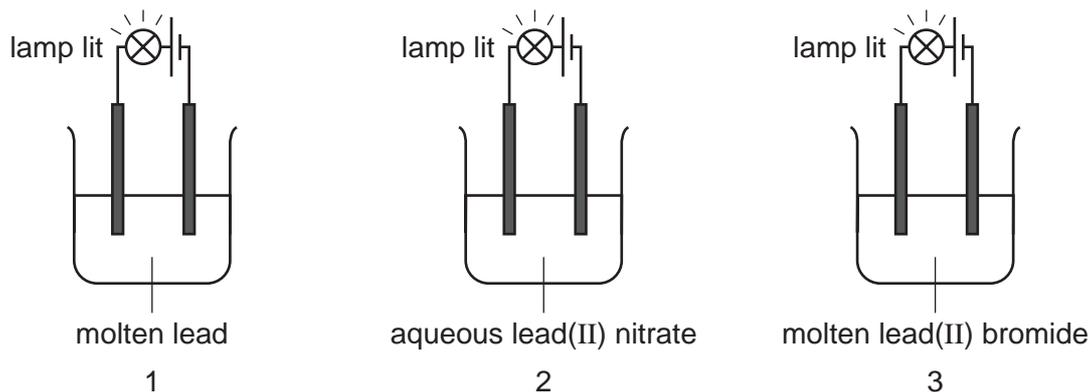

In which experiment is an electrolyte present?

- A 1 and 2 only
- B 1 and 3 only
- C 2 and 3 only
- D 1, 2 and 3

25 A sweet potato is cut into pieces and cooked.

In which pan does the potato cook most quickly?

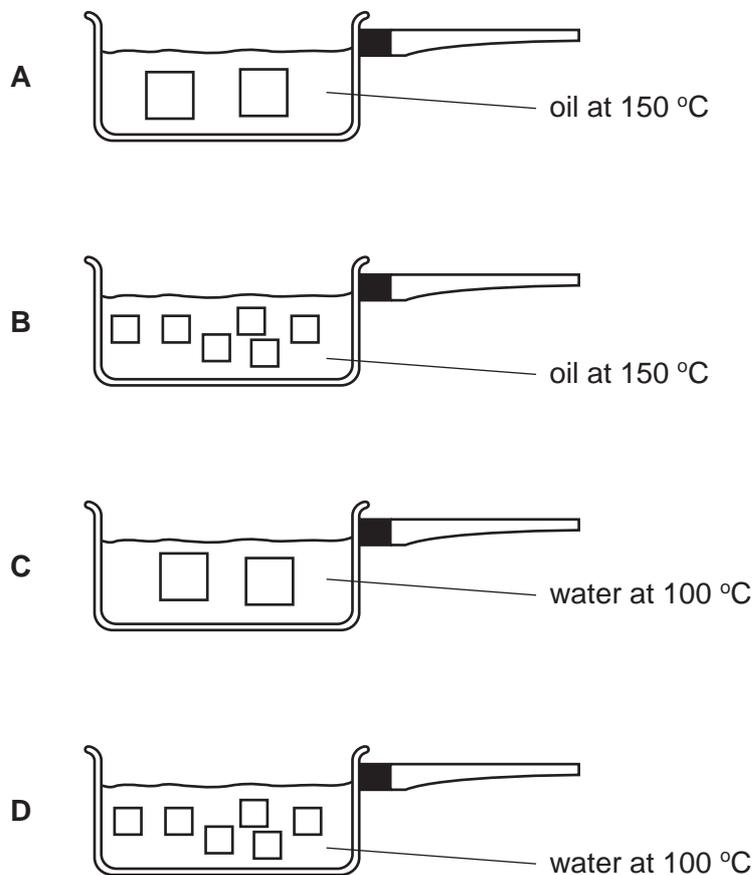

26 Which structure shows a polymer that is also a hydrocarbon?

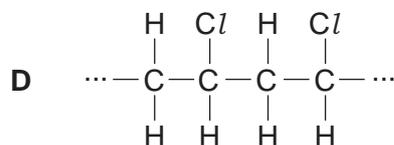
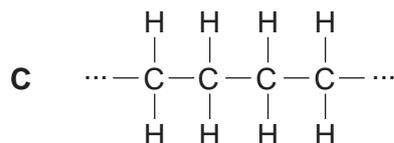
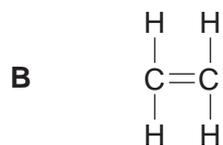
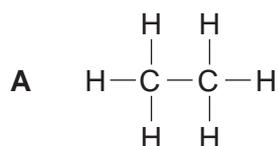

27 Which equation shows the complete combustion of ethane, C_2H_6 ?

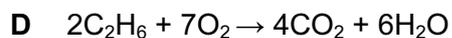
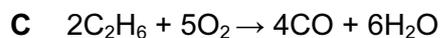
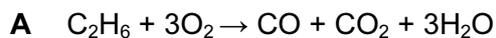

28 A measuring cylinder is used to measure the volume of a liquid.

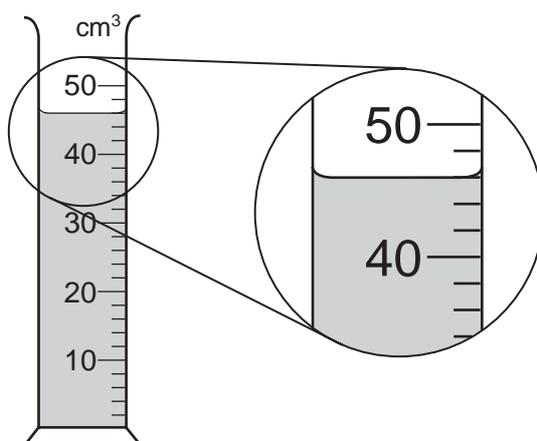

What is the volume of the liquid?

A 43 cm^3

B 46 cm^3

C 48 cm^3

D 54 cm^3

29 An elephant pulls a heavy log along the ground at a steady speed.

Which arrow shows the force of the rope on the log?

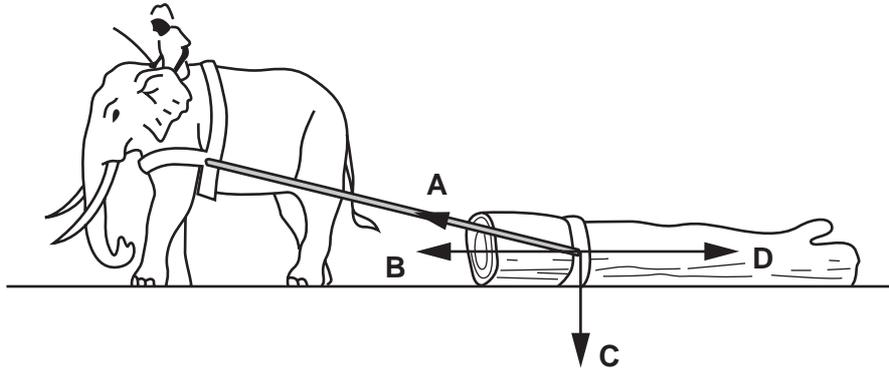

30 The table shows the length of a wire as the load on it is increased.

load / N	0	10	20	30
length / cm	50.0	52.1	54.1	56.3

Which subtraction should be made to find the extension caused by the 20N load?

- A $54.1\text{ cm} - 0\text{ cm}$
- B $54.1\text{ cm} - 50.0\text{ cm}$
- C $54.1\text{ cm} - 52.1\text{ cm}$
- D $56.3\text{ cm} - 54.1\text{ cm}$

31 The arrow in each picture shows the direction of the force exerted by a person.

Which picture shows work being done?

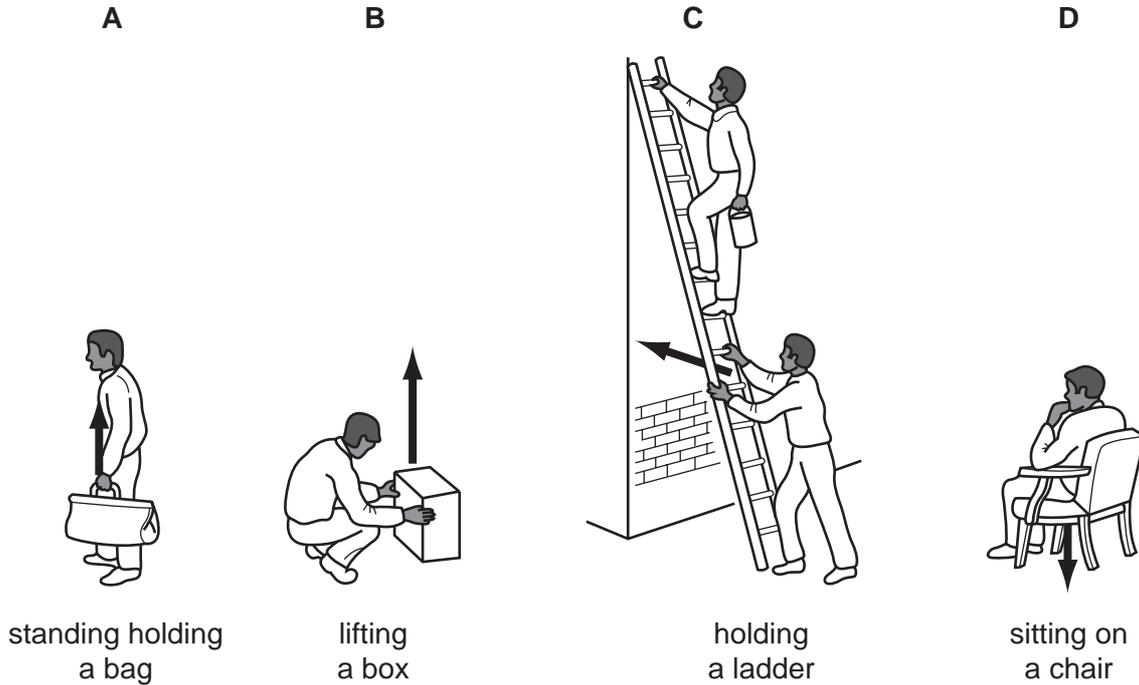

32 The diagram shows a cooling unit in a refrigerator.

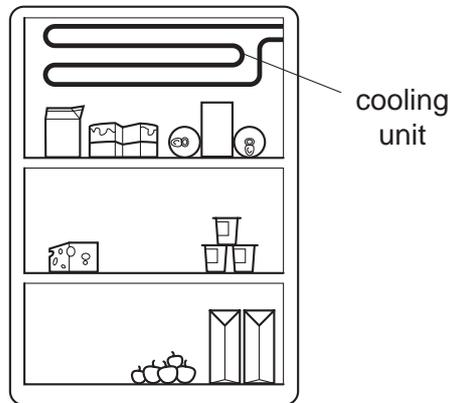

Why is the cooling unit placed at the top?

- A** Cold air falls and warm air is displaced upwards.
- B** Cold air is a bad conductor so heat is not conducted into the refrigerator.
- C** Cold air is a good conductor so heat is conducted out of the refrigerator.
- D** Cold air stops at the top and so prevents convection.

- 33 At the end of a long race, a runner is wrapped in a thin, plastic blanket that has a shiny, metallic surface.

Which type of heat loss is the shiny surface intended to reduce?

- A conduction
- B convection
- C evaporation
- D radiation

- 34 Rays of light enter and leave a box.

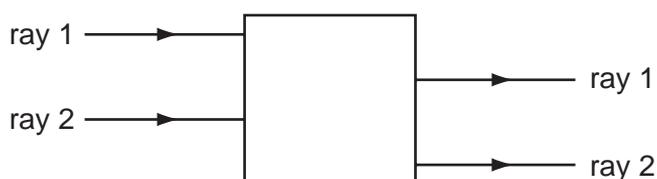

What could be inside the box to make the rays behave as shown?

- A a converging lens
 - B a parallel-sided glass block
 - C a plane mirror
 - D a triangular prism
- 35 Two astronauts without radios can only communicate in space if their helmets are touching. There is no air in space.

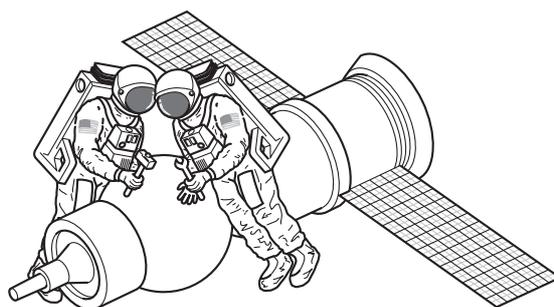

What does this show about sound?

	through a solid	through a vacuum
A	can travel	can travel
B	can travel	cannot travel
C	cannot travel	can travel
D	cannot travel	cannot travel

36 A builder plugs an electric drill into a socket inside a house.

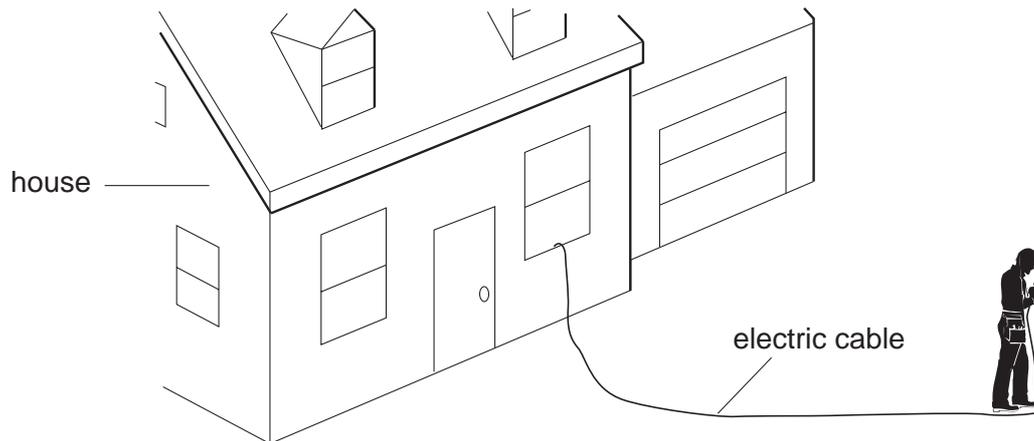

He uses the drill outdoors. It starts to rain heavily.

Why is it dangerous to continue using the electric drill in the rain?

- A The drill could give the builder an electric shock.
- B The drill could overheat.
- C The fuse could blow.
- D The rain could rust the drill.

37 The table shows the voltage and current ratings for four electric heaters.

Which heater has the least resistance?

	voltage/V	current/A
A	110	5.0
B	110	10
C	230	5.0
D	230	10

38 When the circuit shown is connected with switch S open, the 6 V lamp glows.

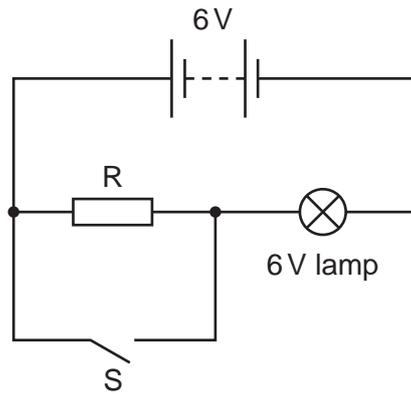

What happens to the brightness of the lamp when switch S is closed?

- A It becomes brighter.
- B It remains the same.
- C It becomes dimmer.
- D It goes off.

39 In the circuit shown, one of the fuses blows and all the lamps go out.

Which fuse blows?

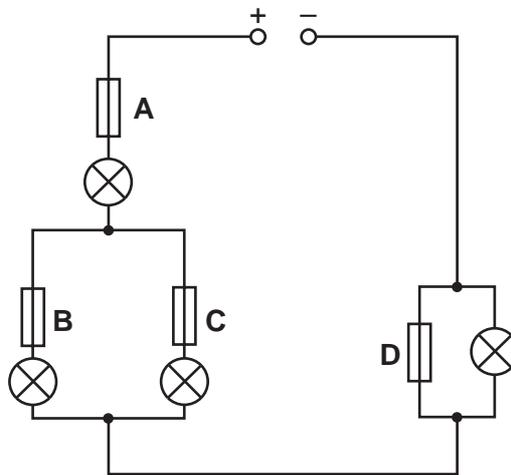

- 40 A radiation detector is placed near a sample of radioactive material and is used to measure the count rate.

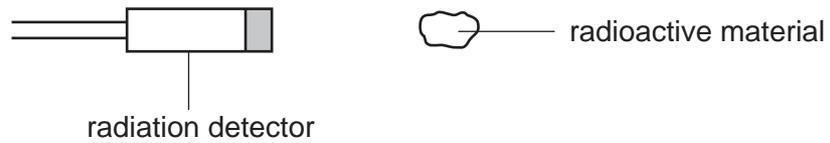

The radioactive material is removed but there is still a count rate.

Why is this?

- A It takes a long time for all emissions from the material to reach the detector.
- B The detector has become radioactive.
- C The radioactive material has not finished decaying.
- D There is always some background radiation.

BLANK PAGE

DATA SHEET
The Periodic Table of the Elements

Group																																							
I	II	III	IV	V	VI	VII	O																																
		1 H Hydrogen 1															4 He Helium 2																						
7 Li Lithium 3	9 Be Beryllium 4																20 Ne Neon 10																						
23 Na Sodium 11	24 Mg Magnesium 12																35.5 Ar Argon 18																						
39 K Potassium 19	40 Ca Calcium 20	45 Sc Scandium 21	48 Ti Titanium 22	51 V Vanadium 23	55 Mn Manganese 25	56 Fe Iron 26	59 Co Cobalt 27	59 Ni Nickel 28	64 Cu Copper 29	65 Zn Zinc 30	70 Ga Gallium 31	73 Ge Germanium 32	75 As Arsenic 33	79 Se Selenium 34	80 Br Bromine 35	84 Kr Krypton 36																							
85 Rb Rubidium 37	88 Sr Strontium 38	89 Y Yttrium 39	91 Zr Zirconium 40	93 Nb Niobium 41	96 Mo Molybdenum 42	101 Ru Ruthenium 44	103 Rh Rhodium 45	106 Pd Palladium 46	108 Ag Silver 47	112 Cd Cadmium 48	115 In Indium 49	119 Sn Tin 50	122 Sb Antimony 51	128 Te Tellurium 52	127 I Iodine 53	131 Xe Xenon 54																							
133 Cs Caesium 55	137 Ba Barium 56	139 La Lanthanum 57	178 Hf Hafnium 72	181 Ta Tantalum 73	184 W Tungsten 74	190 Os Osmium 76	192 Ir Iridium 77	195 Pt Platinum 78	197 Au Gold 79	201 Hg Mercury 80	204 Tl Thallium 81	207 Pb Lead 82	209 Bi Bismuth 83	210 Po Polonium 84	210 At Astatine 85	210 Rn Radon 86																							
226 Ra Radium 88	227 Ac Actinium 89																																						
<p>*58-71 Lanthanoid series 90-103 Actinoid series</p>																																							
<table style="width: 100%; border-collapse: collapse;"> <tr> <td style="border: 1px solid black; padding: 5px;"> <table style="width: 100%; border-collapse: collapse;"> <tr> <td style="border: 1px solid black; padding: 2px;">a</td> <td style="border: 1px solid black; padding: 2px;">X</td> </tr> <tr> <td style="border: 1px solid black; padding: 2px;">b</td> <td style="border: 1px solid black; padding: 2px;">number</td> </tr> </table> </td> <td colspan="17"> <p>a = relative atomic mass X = atomic symbol b = proton (atomic) number</p> </td> </tr> </table>																		<table style="width: 100%; border-collapse: collapse;"> <tr> <td style="border: 1px solid black; padding: 2px;">a</td> <td style="border: 1px solid black; padding: 2px;">X</td> </tr> <tr> <td style="border: 1px solid black; padding: 2px;">b</td> <td style="border: 1px solid black; padding: 2px;">number</td> </tr> </table>	a	X	b	number	<p>a = relative atomic mass X = atomic symbol b = proton (atomic) number</p>																
<table style="width: 100%; border-collapse: collapse;"> <tr> <td style="border: 1px solid black; padding: 2px;">a</td> <td style="border: 1px solid black; padding: 2px;">X</td> </tr> <tr> <td style="border: 1px solid black; padding: 2px;">b</td> <td style="border: 1px solid black; padding: 2px;">number</td> </tr> </table>	a	X	b	number	<p>a = relative atomic mass X = atomic symbol b = proton (atomic) number</p>																																		
a	X																																						
b	number																																						
140 Ce Cerium 58	141 Pr Praseodymium 59	144 Nd Neodymium 60	150 Sm Samarium 62	152 Eu Europium 63	157 Gd Gadolinium 64	162 Dy Dysprosium 66	165 Ho Holmium 67	167 Er Erbium 68	169 Tm Thulium 69	173 Yb Ytterbium 70	175 Lu Lutetium 71																												
232 Th Thorium 90	238 Pa Protactinium 91	238 U Uranium 92	238 Pu Plutonium 94	238 Am Americium 95	238 Cm Curium 96	238 Bk Berkelium 97	238 Cf Californium 98	238 Es Einsteinium 99	238 Fm Fermium 100	238 Md Mendelevium 101	238 No Nobelium 102	238 Lr Lawrencium 103																											

The volume of one mole of any gas is 24 dm³ at room temperature and pressure (r.t.p.).