



UNIVERSITY OF CAMBRIDGE INTERNATIONAL EXAMINATIONS
International General Certificate of Secondary Education

www.XtremePapers.com

COMBINED SCIENCE

0653/01

Paper 1 Multiple Choice

October/November 2007

45 minutes

Additional Materials: Multiple Choice Answer Sheet
Soft clean eraser
Soft pencil (type B or HB recommended)

* 5 5 0 4 5 2 8 3 0 3 *

READ THESE INSTRUCTIONS FIRST

Write in soft pencil.

Do not use staples, paper clips, highlighters, glue or correction fluid.

Write your name, Centre number and candidate number on the Answer Sheet in the spaces provided unless this has been done for you.

There are **forty** questions on this paper. Answer **all** questions. For each question there are four possible answers **A, B, C** and **D**.

Choose the **one** you consider correct and record your choice in **soft pencil** on the separate Answer Sheet.

Read the instructions on the Answer Sheet very carefully.

Each correct answer will score one mark. A mark will not be deducted for a wrong answer.

Any rough working should be done in this booklet.

A copy of the Periodic Table is printed on page 16.

This document consists of **16** printed pages.



1 Which cell has **no** DNA?

- A goblet cell
- B red blood cell
- C sperm cell
- D spongy mesophyll cell

2 A plant cell is placed in a sugar solution that is more concentrated than the cell sap.

The diagram shows the appearance of the cell after 10 minutes.

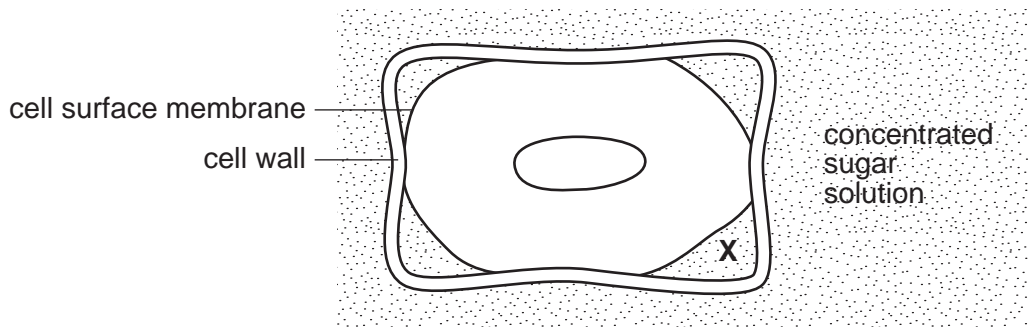

Why does space **X** become filled with sugar solution?

- A The cell wall and cell surface membrane are both fully permeable.
 - B The cell wall and cell surface membrane are both partially permeable.
 - C The cell wall is fully permeable and the cell surface membrane is partially permeable.
 - D The cell wall is partially permeable and the cell surface membrane is fully permeable.
- 3 Which gas is given off when the enzyme catalase is added to a solution of hydrogen peroxide?
- A carbon dioxide
 - B carbon monoxide
 - C hydrogen
 - D oxygen

- 4 A water plant is exposed to sunlight. After a short period of time bubbles are given off from the plant.

Which gas do the bubbles contain, and which process produces this gas?

	gas	process
A	carbon dioxide	photosynthesis
B	carbon dioxide	respiration
C	oxygen	photosynthesis
D	oxygen	respiration

- 5 What is a symptom of vitamin C deficiency?

- A** bleeding from skin and gums
- B** developing soft bones
- C** low red blood cell count
- D** teeth decay easily

- 6 The diagram shows apparatus that can be used to demonstrate that the air breathed out by a person contains more carbon dioxide than the air breathed in.

The person breathes in and out at X.

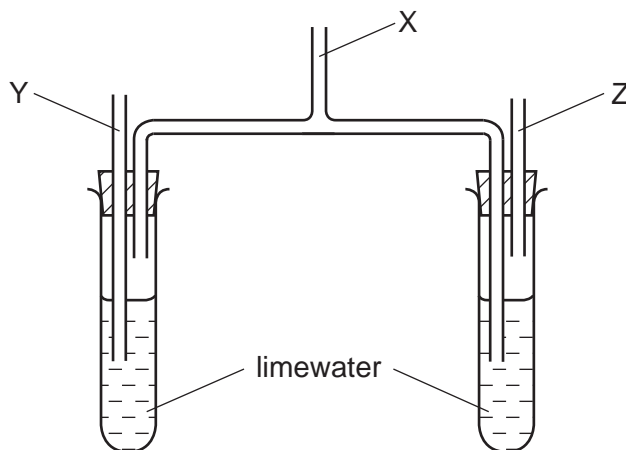

Where does air enter and leave the apparatus?

	air enters at	air leaves at
A	Y	Y
B	Y	Z
C	Z	Y
D	Z	Z

7 The diagram shows part of the human nervous system.

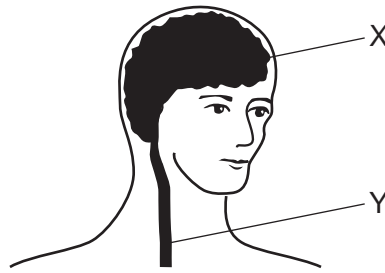

What are X and Y?

	X	Y
A	brain	effector
B	brain	spinal cord
C	receptor	effector
D	receptor	spinal cord

8 The diagram shows a section through the heart.

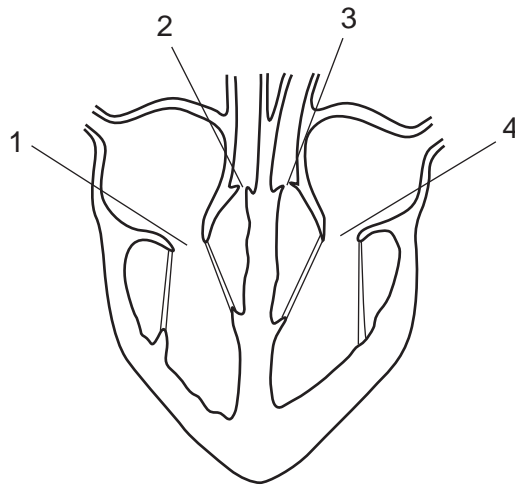

The ventricles contract and blood is forced into the arteries.

What is the state of valve 3 and 4 when this happens?

	valve 3	valve 4
A	closed	closed
B	closed	open
C	open	closed
D	open	open

- 9 It is possible to grow plants that are genetically identical.

What are plants grown in this way called?

- A clones
- B gametes
- C seeds
- D zygotes

- 10 The diagram shows the male reproductive system.

Which tube is cut when carrying out male sterilisation (a vasectomy)?

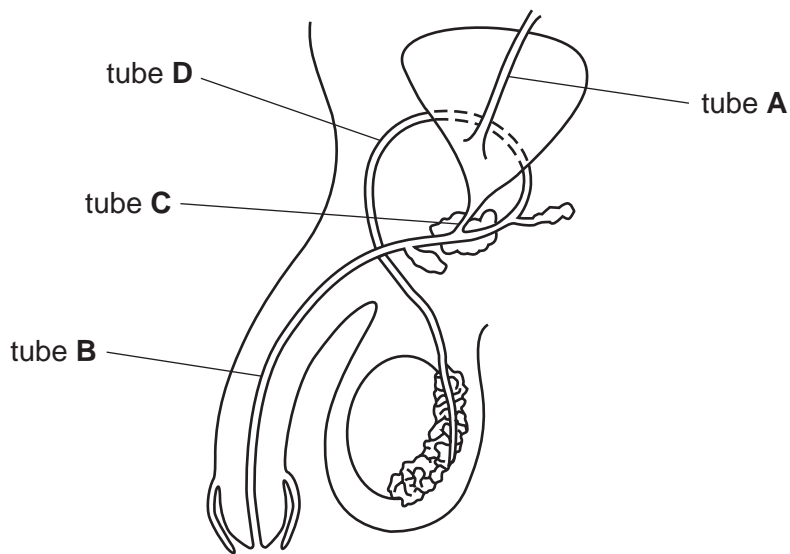

- 11 In which part of a plant is the embryo found?

- A anther
- B pollen grain
- C seed
- D stigma

- 12 Jamal and Javan are identical twins, but Jamal is 10 kg heavier than Javan.

What will have caused the difference in their weights?

	genes	environment
A	✓	✓
B	✓	x
C	x	✓
D	x	x

key
 ✓ = yes
 x = no

13 The diagram shows a food chain.



What is represented by the black arrows and by the white arrows?

	black arrows	white arrows
A	chemical energy	heat
B	chemical energy	sunlight
C	heat	chemical energy
D	sunlight	chemical energy

14 When a metal X is added to water, it reacts and two ions are formed.

What could these ions be?

- A** Cu^{2+} , H^+
- B** Cu^{2+} , OH^-
- C** Na^+ , H^+
- D** Na^+ , OH^-

15 Which two elements combine to form an ionic compound?

- A** carbon and oxygen
- B** chlorine and magnesium
- C** copper and zinc
- D** hydrogen and oxygen

16 Which displayed formulae correctly represent a molecule of carbon dioxide and of nitrogen?

	carbon dioxide, CO_2	nitrogen, N_2
A	$\text{O}-\text{C}-\text{O}$	$\text{N}-\text{N}$
B	$\text{O}-\text{C}-\text{O}$	$\text{N}\equiv\text{N}$
C	$\text{O}=\text{C}=\text{O}$	$\text{N}-\text{N}$
D	$\text{O}=\text{C}=\text{O}$	$\text{N}\equiv\text{N}$

- 17 Two products, X and Y, are formed in the complete combustion of methane.

What are X and Y?

- A carbon and hydrogen
- B carbon and water
- C carbon dioxide and hydrogen
- D carbon dioxide and water

- 18 The diagram shows a simplified outline of the Periodic Table.

Which letter shows the position of a metal with a low melting point?

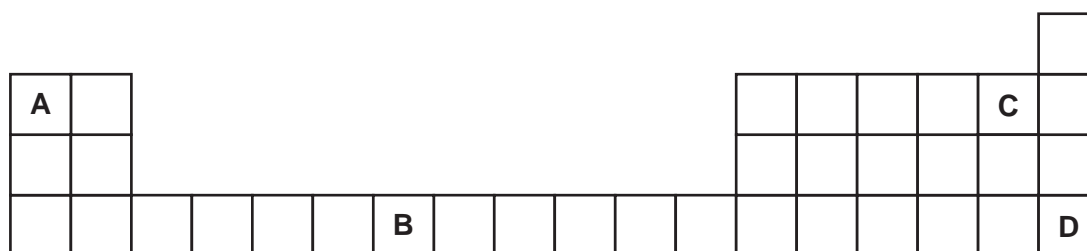

- 19 An oxide of lead is changed to lead by heating it with carbon.

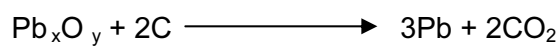

What is the formula of this oxide of lead?

- A Pb_2O_3
 - B Pb_3O_2
 - C Pb_3O_4
 - D Pb_4O_3
- 20 The diagrams show molecules of four gases present in clean air. Different circles represent atoms of different elements.

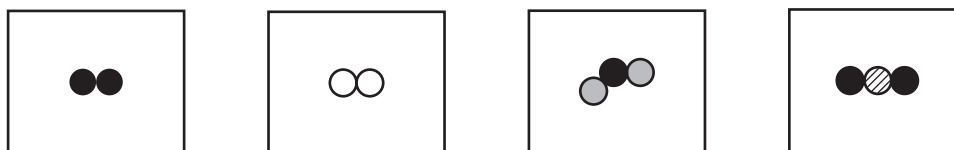

Which elements could be shown as ● and ○?

	●	○
A	hydrogen	nitrogen
B	hydrogen	oxygen
C	oxygen	hydrogen
D	oxygen	nitrogen

21 Which substance has a dangerously explosive reaction with sodium?

- A ammonia
- B hydrogen
- C hydrochloric acid
- D nitrogen

22 Aluminium oxide, dissolved in melted cryolite, is electrolysed.

Aluminium is produced by1..... and energy is2..... .

Which words correctly complete the gaps?

	gap 1	gap 2
A	oxidation	given out
B	oxidation	used up
C	reduction	given out
D	reduction	used up

23 Which word equation shows a thermal decomposition?

- A ammonia + nitric acid → ammonium nitrate
- B hydrogen + oxygen → water
- C magnesium carbonate → magnesium oxide + carbon dioxide
- D potassium chloride + silver nitrate → potassium nitrate + silver chloride

24 The diagram shows an apparatus used for electrolysis.

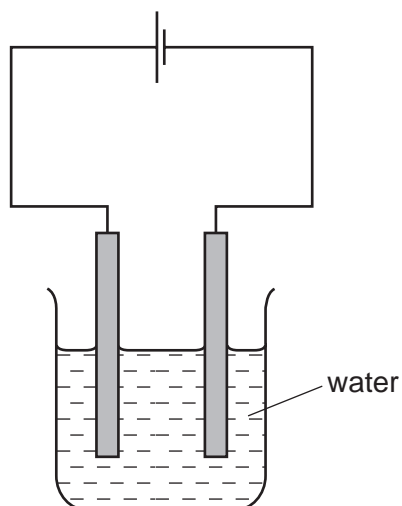

Which substance, when added to water, would act as an electrolyte?

- A calcium carbonate
- B copper(II) chloride
- C graphite
- D sugar

25 Are iron and sodium hydroxide obtained by electrolysis?

	iron	sodium hydroxide
A	✓	✓
B	✓	x
C	x	✓
D	x	x

26 The description below of a plastic is incomplete.

To make a plastic,1..... of a2..... combine to form a long chain3..... .

Which words correctly complete the gaps?

	gap 1	gap 2	gap 3
A	atoms	monomer	polymer
B	atoms	polymer	monomer
C	molecules	monomer	polymer
D	molecules	polymer	monomer

27 Ethanol, hydrogen and methane are used as fuels.

Which line in the table is correct?

	ethanol	hydrogen	methane
A	solid	gas	gas
B	solid	liquid	liquid
C	liquid	gas	gas
D	liquid	liquid	liquid

28 Some water is poured into four tubes of different cross-sectional areas.

Which tube contains the largest volume of water?

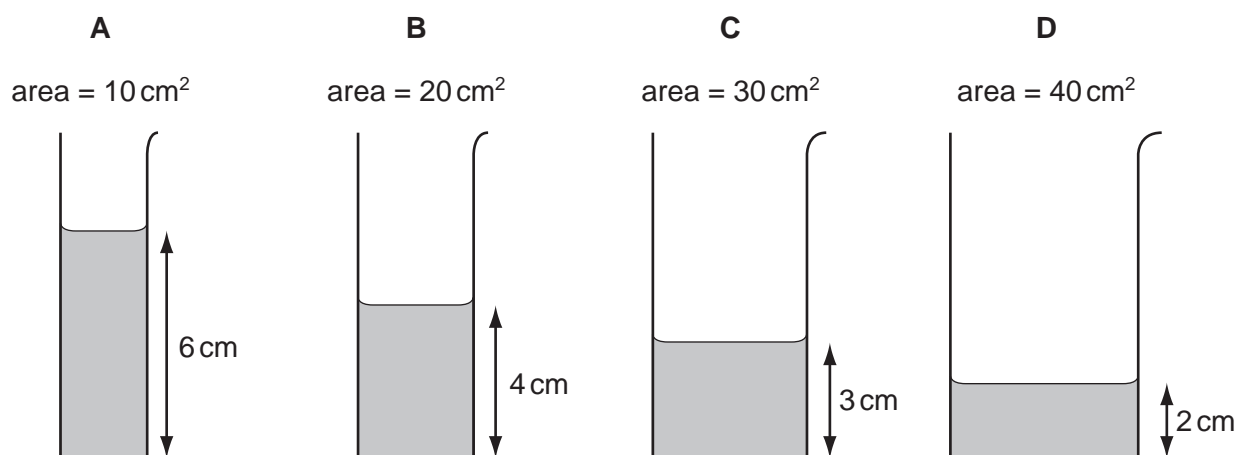

29 Four students try to explain what is meant by acceleration.

Which student makes a correct statement?

- A** It is related to the changing speed of an object.
- B** It is the distance an object travels in one second.
- C** It is the force acting on an object divided by the distance it travels in one second.
- D** It is the force acting on an object when it is near to the Earth.

30 What are the correct units for force and for weight?

	force	weight
A	kg	kg
B	kg	N
C	N	kg
D	N	N

- 31 A metal drum has a mass of 200 kg when empty and 1000 kg when filled with 1.0 m^3 of methylated spirit.

What is the density of methylated spirit?

- A 0.0050 kg/m^3
 B 0.11 kg/m^3
 C 800 kg/m^3
 D 1000 kg/m^3

- 32 A spring is suspended from a stand. Loads are added and the extensions are measured.

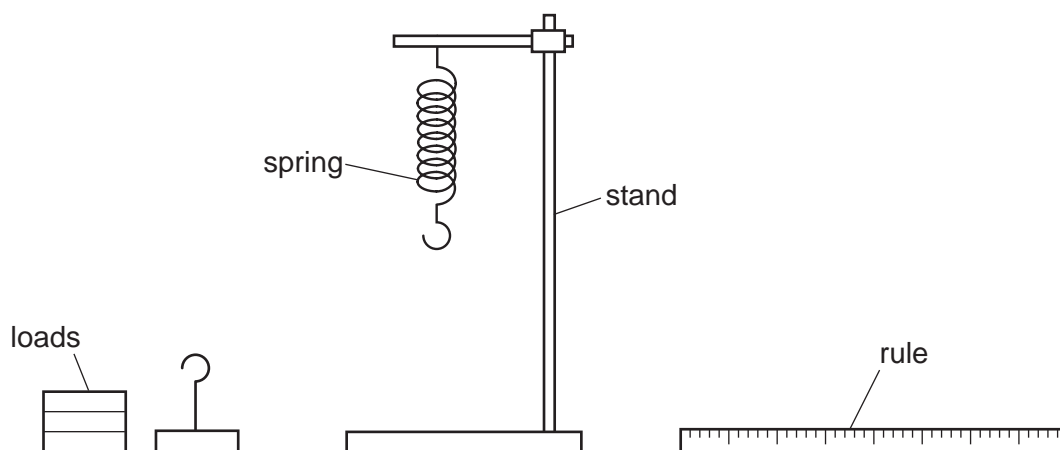

Which graph shows the result of plotting extension against load?

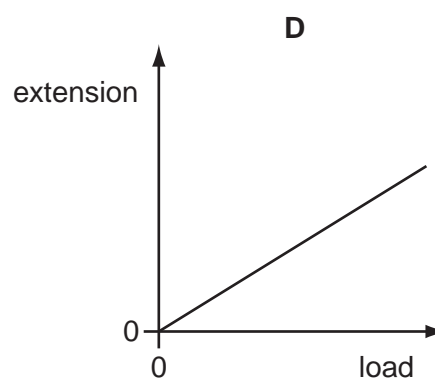
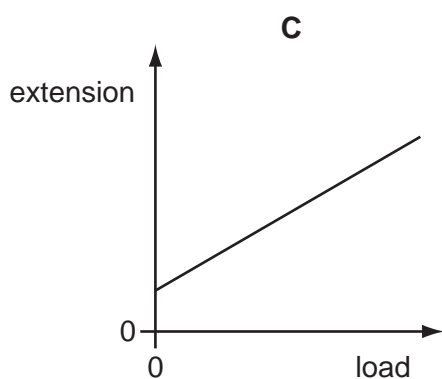
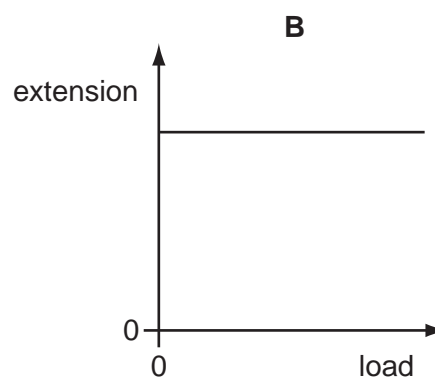
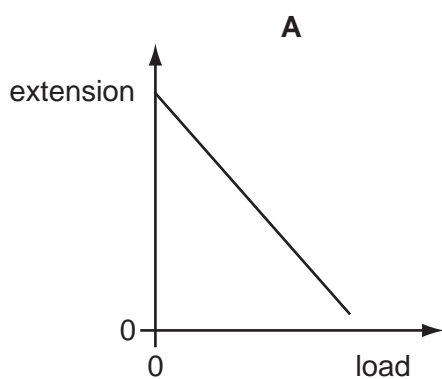

33 A person uses chemical energy to run up some stairs.

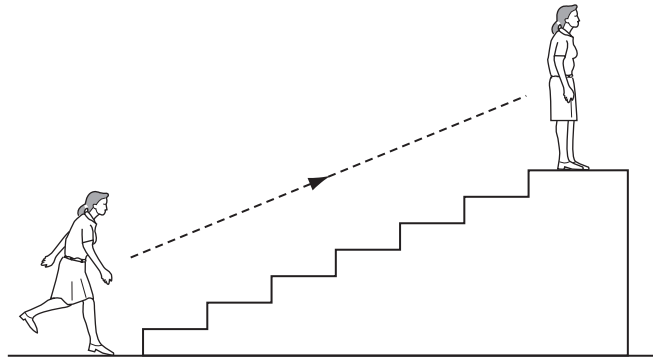

She stops at the top of the stairs.

What has the chemical energy been converted to when she is at the top of the stairs?

- A kinetic energy and potential energy
- B kinetic energy and nuclear energy
- C potential energy and heat energy
- D nuclear energy and heat energy

34 A wooden wheel can be strengthened by putting a tight circle of iron around it.

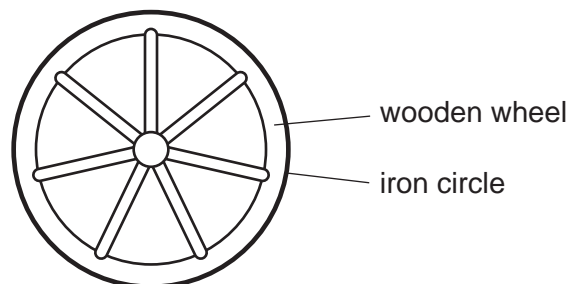

Which action would make it easier to fit the circle over the wood?

- A cooling the iron circle
- B heating the iron circle
- C heating the wooden wheel
- D heating the wooden wheel and cooling the iron circle

35 Which statement refers to convection?

- A It does not involve energy transfer.
- B It is the transfer of heat energy without the movement of particles.
- C It only occurs in liquids or gases.
- D It only occurs in solids.

36 The circuit shows a current I in a resistor of resistance R .

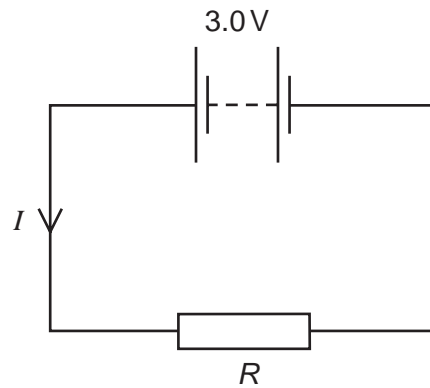

Which line gives possible values of I and R ?

	I/A	R/Ω
A	1.5	1.5
B	1.5	2.0
C	6.0	2.0
D	4.0	12

37 Four lamps are connected in a circuit as shown in the diagram.

Each lamp is designed to operate at 12V.

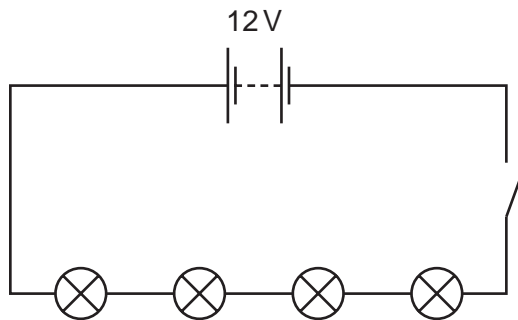

The circuit is now switched on.

Which statement is correct?

- A** Each lamp can be switched off independently.
- B** If one lamp breaks all the others will stay alight.
- C** The current is the same in all the lamps.
- D** The lamps will all light at normal brightness.

38 The diagram shows four electric kettles plugged into a 4-way adaptor.

An extension lead connects the adaptor to a single mains plug.

The mains plug is designed to work without a fuse.

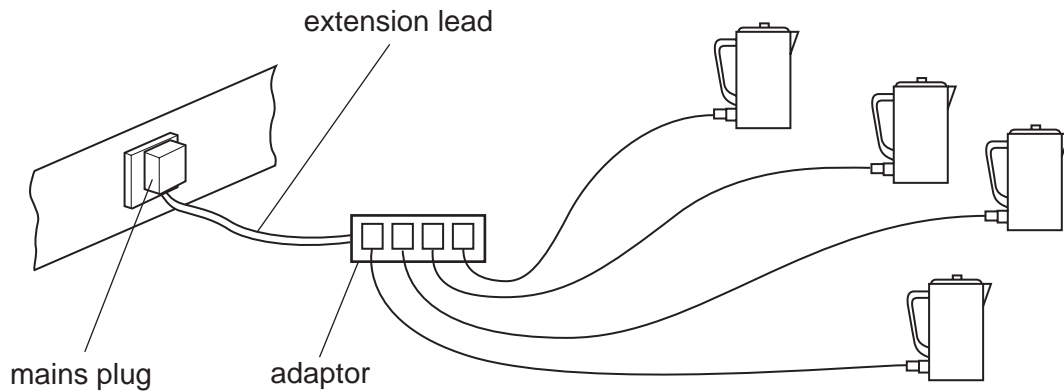

Why is this use of the adaptor dangerous?

- A The heating elements in the kettle will overheat.
- B The extension lead connecting the adaptor to the mains plug will overheat.
- C The leads connecting the kettles to the adaptor will overheat.
- D The water in the kettles will overheat.

39 How is electricity transmitted over large distances and why is it transmitted in this way?

	how	why
A	at high voltage	for safety
B	at high voltage	to reduce energy loss
C	at low voltage	for safety
D	at low voltage	to reduce energy loss

40 A sheet of paper is placed between a radioactive source and a detector.

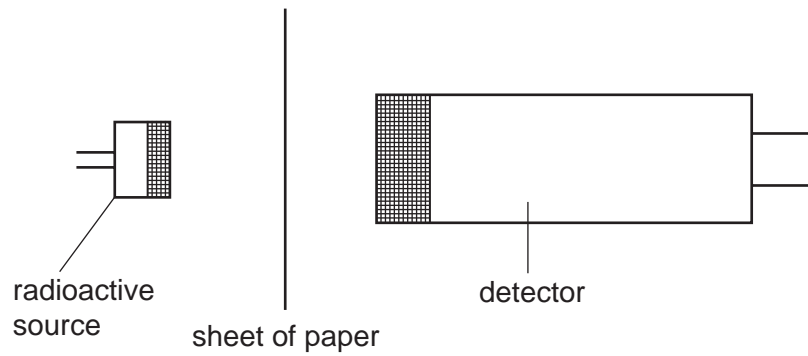

Which types of radiation can pass through the paper?

- A alpha-particles and beta-particles only
- B alpha-particles and gamma-rays only
- C beta-particles and gamma-rays only
- D alpha-particles, beta-particles and gamma-rays

DATA SHEET
The Periodic Table of the Elements

		Group										
		I	II	III	IV	V	VI	VII	VIII	IX	X	0
		1 H Hydrogen 1										4 He Helium 2
7 Li Lithium 3	9 Be Beryllium 4											19 F Fluorine 9
23 Na Sodium 11	24 Mg Magnesium 12	11 B Boron 5	12 C Carbon 6	13 Al Aluminium 13	14 Si Silicon 14	15 P Phosphorus 15	16 S Sulphur 16	17 Cl Chlorine 17	18 Ar Argon 18	20 Ne Neon 10	35.5 Br Bromine 35	36 Kr Krypton 36
39 K Potassium 19	40 Ca Calcium 20	27 Ga Gallium 31	28 Ge Germanium 32	29 Ni Nickel 28	30 Zn Zinc 30	31 As Arsenic 33	32 Se Selenium 34	33 Br Bromine 35	34 Kr Krypton 36	35 Br Bromine 35	36 Kr Krypton 36	37 Rb Rubidium 37
85 Rb Rubidium 37	88 Sr Strontium 38	45 Sc Scandium 21	46 Ti Titanium 22	47 V Vanadium 23	48 Cr Chromium 24	49 Mn Manganese 25	50 Fe Iron 26	51 Co Cobalt 27	52 Ni Nickel 28	53 Cu Copper 29	54 Zn Zinc 30	55 Ga Gallium 31
133 Cs Caesium 55	137 Ba Barium 56	89 Y Yttrium 39	90 Zr Zirconium 40	91 Nb Niobium 41	92 Mo Molybdenum 42	93 Tc Technetium 43	94 Ru Ruthenium 44	95 Rh Rhodium 45	96 Pd Palladium 46	97 Ag Silver 47	98 Cd Cadmium 48	99 In Indium 49
226 Fr Francium 87	227 Ra Radium 88	101 Re Rhenium 75	102 Os Osmium 76	103 Ir Iridium 77	104 Pt Platinum 78	105 Au Gold 79	106 Hg Mercury 80	107 Tl Thallium 81	108 Pb Lead 82	109 Bi Bismuth 83	110 Po Polonium 84	111 At Astatine 85
		140 Ce Cerium 58	141 Pr Praseodymium 59	142 Nd Neodymium 60	143 Pm Promethium 61	144 Sm Samarium 62	145 Eu Europium 63	146 Gd Gadolinium 64	147 Tb Terbium 65	148 Dy Dysprosium 66	149 Ho Holmium 67	150 Er Erbium 68
		232 Th Thorium 90	233 Pa Protactinium 91	234 U Uranium 92	235 Np Neptunium 93	236 Pu Plutonium 94	237 Am Americium 95	238 Cm Curium 96	239 Bk Berkelium 97	240 Cf Californium 98	241 Es Einsteinium 99	242 Fm Fermium 100
		173 Yb Ytterbium 70	174 Lu Lutetium 71	175 Lu Lutetium 71	176 Yb Ytterbium 70	177 No Nobelium 102	178 Yb Ytterbium 70	179 Lu Lutetium 71	180 Lu Lutetium 71	181 Lu Lutetium 71	182 Lu Lutetium 71	183 Lu Lutetium 71

*58-71 Lanthanoid series
†90-103 Actinoid series

a	X
b	X

a = relative atomic mass
X = atomic symbol
b = proton (atomic) number

The volume of one mole of any gas is 24 dm³ at room temperature and pressure (r.t.p.).