

Centre Number	Candidate Number	Name
---------------	------------------	------

UNIVERSITY OF CAMBRIDGE INTERNATIONAL EXAMINATIONS
International General Certificate of Secondary Education

COMBINED SCIENCE
CO-ORDINATED SCIENCES

0653/06
0654/06

Paper 6 Alternative to Practical

May/June 2004

1 hour

Candidates answer on the Question Paper.
No Additional Materials are required.

READ THESE INSTRUCTIONS FIRST

Write your Centre number, candidate number and name on all the work you hand in.
Write in dark blue or black pen in the spaces provided on the Question Paper.
You may use a soft pencil for any diagrams, graphs or rough working.
Do not use staples, paper clips, highlighters, glue or correction fluid.

Answer **all** questions.
The number of marks is given in brackets [] at the end of each question or part question.

For Examiner's Use	
1	
2	
3	
4	
5	
6	
Total	

If you have been given a label, look at the details. If any details are incorrect or missing, please fill in your correct details in the space given at the top of this page.

Stick your personal label here, if provided.

This document consists of **17** printed pages and **3** blank pages.



- 1 Two plants, **A** and **B** have variegated leaves. One of the plants was kept in the dark for 48 hours. A student wanted to find out which plant had been kept in the dark. He did this by testing for starch in a leaf taken from each plant.

He removed a leaf from each plant and cut strips 1 cm wide from the middle of each leaf as shown in Fig. 1.1.

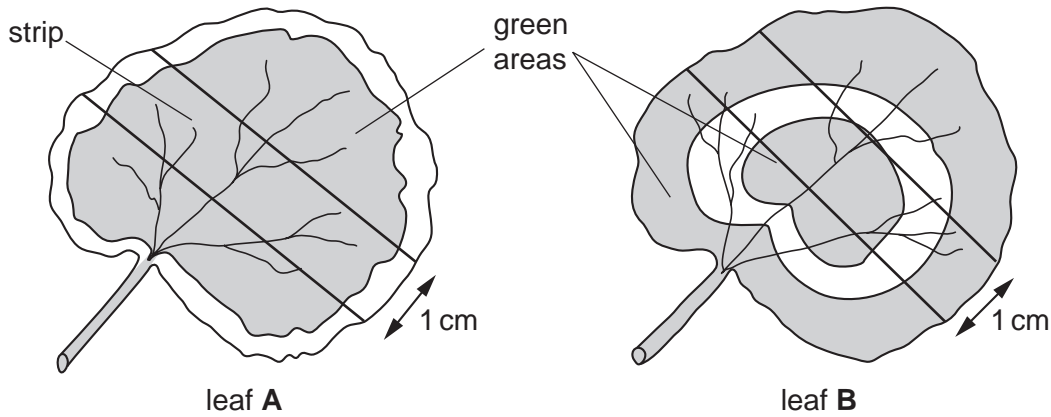

Fig. 1.1

- (a) Make large, clear drawings of the leaf strips in the spaces below, labelling clearly the areas where there is chlorophyll.

leaf **A**

leaf **B**

[2]

He then tested both strips for the presence of starch using the following method.

- He placed the leaf strip in a beaker of boiling water for one minute.
- He then took it out and put it into a test-tube.
- He turned the Bunsen burner off.
- Then he added alcohol to the leaf in the tube and placed the tube into the beaker of hot water until the chlorophyll was removed from the leaf.
- He poured the alcohol out of the tube and rinsed the leaf using cold water.
- Then he spread the leaf out on a white tile, covered it with iodine solution and waited for any colour change to develop.

Results

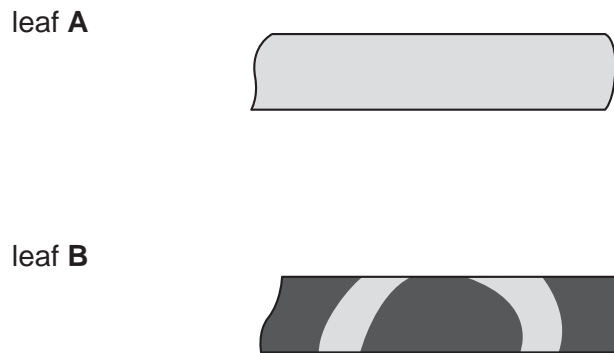

Fig. 1.2

(b) Add labels to Fig. 1.2 to show the actual colours observed after treatment of both leaf strips with iodine solution. [2]

(c) (i) Which plant, **A** or **B**, has been kept in the dark?

.....

Explain your answer.

.....
[2]

(ii) Explain the pattern of distribution of starch observed.

.....
[2]

- 2 A student investigated how the current passing through a light bulb was affected by changing the applied voltage. Fig. 2.1 shows the circuit that he used.

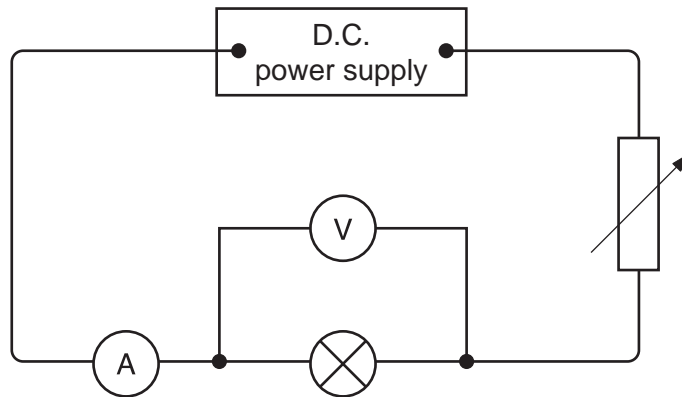

Fig. 2.1

- He set the variable resistor to the highest value.
- He wrote down the readings of the milliammeter and voltmeter in Fig. 2.2.
- He decreased the resistance of the variable resistor and then read the milliammeter and voltmeter again, repeating this several times.
- He plotted a graph of voltage against current, Fig. 2.4.

voltage/volts	current/milliamps
0.5	35
1.1	80
2.0	170
2.5	280

Fig. 2.2

- (a) Fig. 2.3 shows the voltmeter and milliammeter for the two missing sets of readings. Read the meters and complete Fig. 2.2. [3]

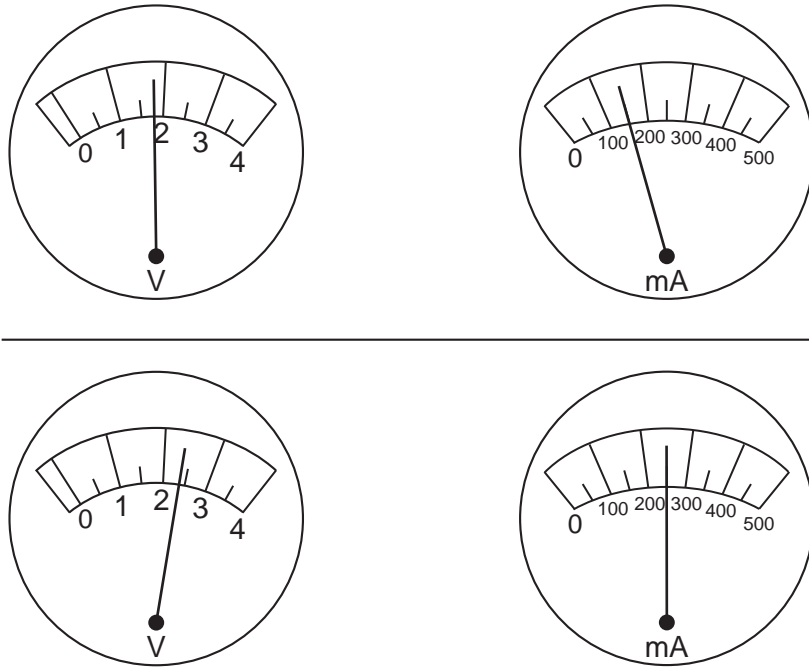

Fig. 2.3

- (b) Fig. 2.4 shows the graph grid with some of the points already plotted. Plot your readings from (a), and draw a suitable line through the points. [3]

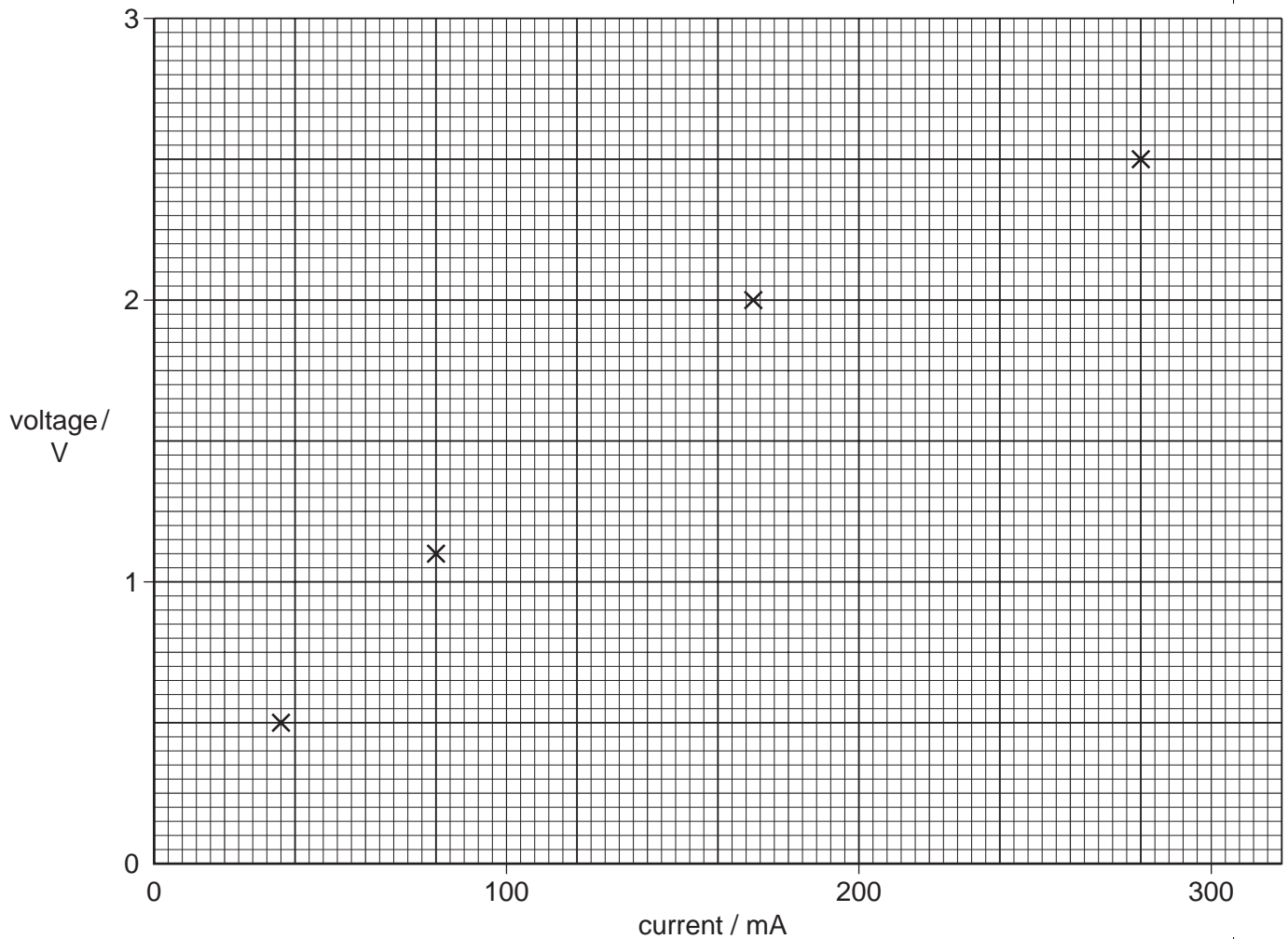

Fig. 2.4

- (c) (i) Explain how the brightness of the bulb changed as the resistance of the variable resistor was decreased.

.....
[1]

- (ii) Explain why the current might suddenly drop to zero above a certain applied voltage.

.....[1]

- (d) Did the light bulb obey Ohm's Law? Explain your answer.

.....[1]

3 A student made a sample of copper(II) nitrate, a blue crystalline salt.

- He weighed out a sample of copper into a beaker. He placed the beaker in a fume cupboard and then added some concentrated nitric acid. A poisonous acidic gas was given off. When the reaction had finished, some copper remained in the beaker.
- He separated the excess copper from the solution.
- Then he obtained copper(II) nitrate crystals from the solution.

(a) Fig. 3.1 shows the balance windows for weighing the copper.

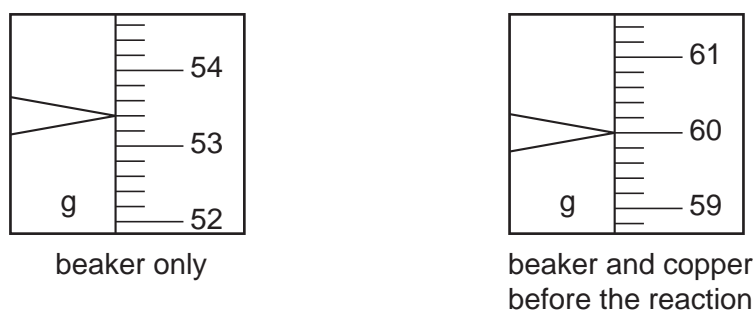

Fig. 3.1

(i) Record the balance readings in the spaces below.

mass of beaker only = g

mass of beaker and copper = g

(ii) Calculate the mass of copper in the beaker.

mass of copper in the beaker = g [3]

(b) Carefully explain how the student can show that the gas given off during the reaction between copper and nitric acid is acidic.

.....
[1]

- (c) The student washed, dried and weighed the excess copper in the beaker. Fig. 3.2 shows the balance reading for the beaker and the excess copper left after the reaction.

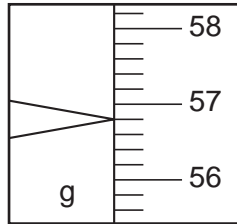

beaker and copper left over
after the reaction

Fig. 3.2

- (i) Record the reading in the space below.

mass of beaker and excess copper =

- (ii) Calculate the mass of copper that was used up in the reaction with the nitric acid.

mass of copper that reacted with the nitric acid = g [1]

- (d) Copper(II) nitrate forms blue crystals that decompose if they are heated. Carefully explain how the student could obtain copper(II) nitrate crystals from the solution.

.....

 [2]

- (e) The student collected and weighed the crystals in the same beaker that he used before. Fig. 3.3 shows the balance reading.

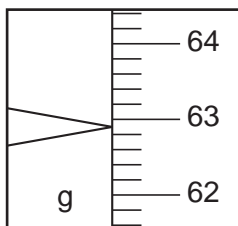

beaker and copper nitrate crystals

Fig. 3.3

- (i) Record the reading in the space below.

mass of beaker and copper(II) nitrate crystals =

- (ii) Calculate the mass of copper (II) nitrate crystals.

mass of copper(II) nitrate crystals = g [2]

- (f) The teacher said that the mass of copper dissolved by the acid would make 12.1 g of hydrated copper(II) nitrate. Suggest **one** reason why the student did not get as much copper(II) nitrate crystals as this.

.....

.....[1]

4 A student did an experiment to compare the amount of energy produced by two different potato snacks when they were burned. We shall call them 'rings' and 'cheesos'.

- The student used a chemical balance to find the mass of the first snack sample, a ring, and recorded it.
- She set up the apparatus as shown in Fig. 4.1.

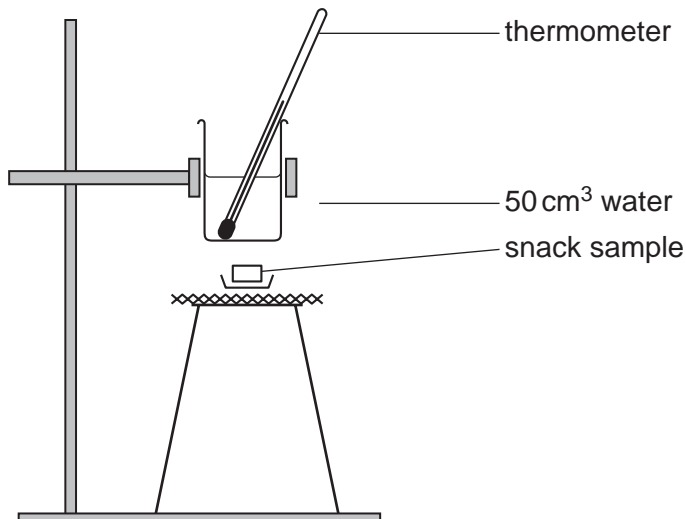
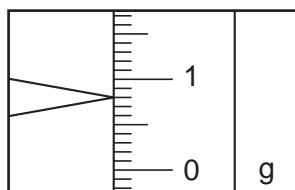

Fig. 4.1

- She noted the temperature of the water, then set fire to the ring, so that the heat from the burning ring heated the water.
- When the ring finished burning she noted the temperature of the water.
- She then repeated the experiment with the cheeso.

(a) Read the balance windows below and record the masses of the two snacks in the spaces provided.



ring g

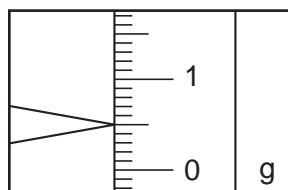

cheeso g

[2]

- (b) The initial temperature of the water was 25 °C for each experiment. Read the thermometers below to find the final temperature of the water.

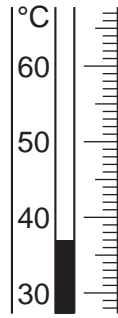
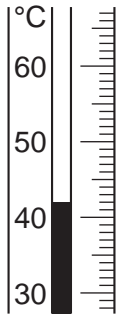

ring °C

cheeso °C

[2]

- (c) (i) Calculate the rise in temperature for each of the two snacks.

ring °C

cheeso °C

[2]

- (ii) Use the formula below to calculate the amount of energy given out by 1 gram of each food. The mass of water used each time was 50 grams. Show your working, including the unit for energy given out.

$$\text{energy given out} = \frac{\text{mass of water (g)} \times \text{temperature rise (}^\circ\text{C)} \times 4.2}{\text{mass of the snack (g)}}$$

energy given out by ring = unit

energy given out by cheeso = unit

[5]

- (d) Name the process that releases energy in the human body.

.....[1]

- 5 Tests were carried out on two white crystalline solids, **A** and **B**. Fig. 5.1 shows the observations and the conclusions of some of the tests.

(a) Complete the table, Fig. 5.1.

test	observations	conclusions
1. A portion of solid A was strongly heated. The gas given off was tested with limewater.	<i>The limewater changed from</i> <i>to</i>	[1] [1]
2. A portion of solid B was strongly heated. The gas given off was tested with (a) a lighted splint (b) limewater	<i>the flame was extinguished.</i> <i>the limewater changed as it did in test 1.</i>	[1] [1]
3. A portion of solid A was dissolved in water. Universal Indicator was added.	<i>The colour of the Universal Indicator changed from</i> <i>to</i>	<i>Solid A is an acid.</i> [2]
4. A portion of solid B was dissolved in water. Universal Indicator was added to the solution.	<i>The colour of the Universal Indicator changed from</i> <i>to</i>	<i>The pH of the solution of solid B is about 6.</i> [1]

Fig. 5.1

- (b) When solid **A** is mixed with solid **B** and water is added, a gas is given off. Describe how you would measure the volume of this gas. You can answer this question by drawing a labelled diagram in the space below.

[3]

- 6 A student read that an object floats in water when its density is less than that of water.

When the density of the object is just greater than that of water, it will sink. When the mass in g of a vessel placed in water is just greater than its volume in cm³, it will sink, since the density of water is equal to 1 g/cm³.

The student decided to test this statement by carrying out an experiment using a plastic drinking cup.

- (a) To find the volume of water that the cup would hold, he filled a measuring cylinder up to the 250 cm³ mark. He poured water from the measuring cylinder into the cup until it was completely full. He did not let any water spill over. Suggest a way of putting the last few drops of water into the cup so that it is full but not spilling over.

.....[1]

(b) Fig. 6.1 shows the scale of the measuring cylinder after the cup was filled.

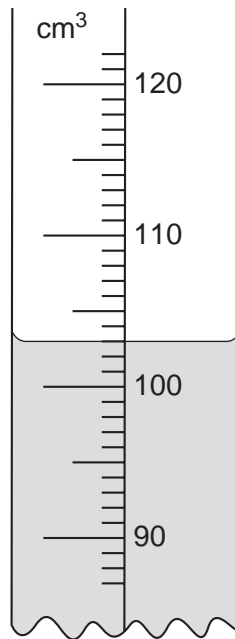

Fig. 6.1

- (i) Record the volume of water left in the 250 cm³ measuring cylinder in the space below.

volume of water left in the measuring cylinder cm³ [1]

- (ii) Calculate the volume of water placed in the cup.

volume of water in the cup cm³ [1]

The student emptied all the water out of the cup, then he placed 50 cm^3 of water into it. He placed the cup into a beaker about half-full of water. See Fig. 6.2.

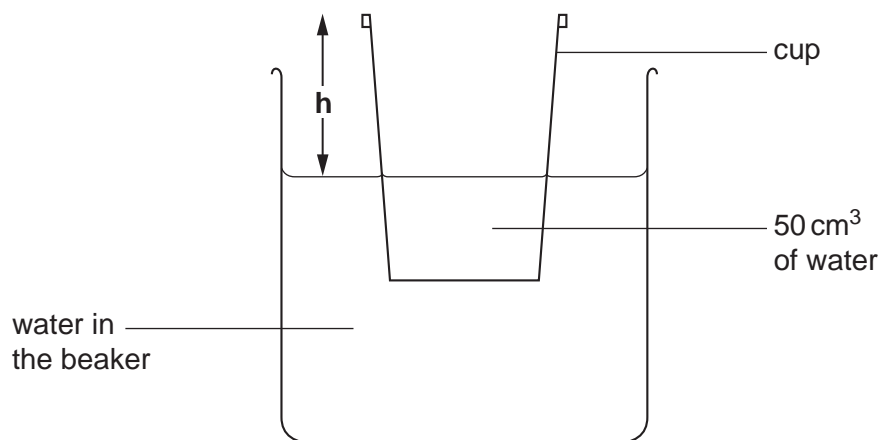

Fig. 6.2

He measured the distance h mm shown in Fig. 6.2, and recorded it in the table, Fig. 6.3.

volume of water in the cup/ cm^3	height h / mm
50	36
70	
90	22
110	
130	6

Fig. 6.3

The student put another 20 cm^3 of water into the cup, and measured h again. He repeated this, adding 20 cm^3 of water each time until a total of 130 cm^3 was reached.

- (c) Fig. 6.4 shows the cup floating in the water for two of the boxes in Fig. 6.3. Measure and record the vertical height h each time. [2]

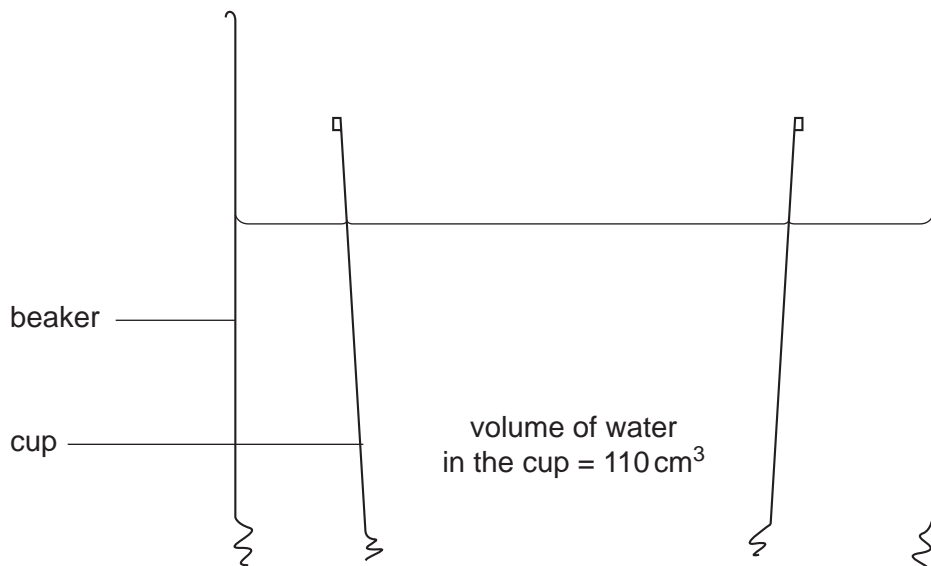
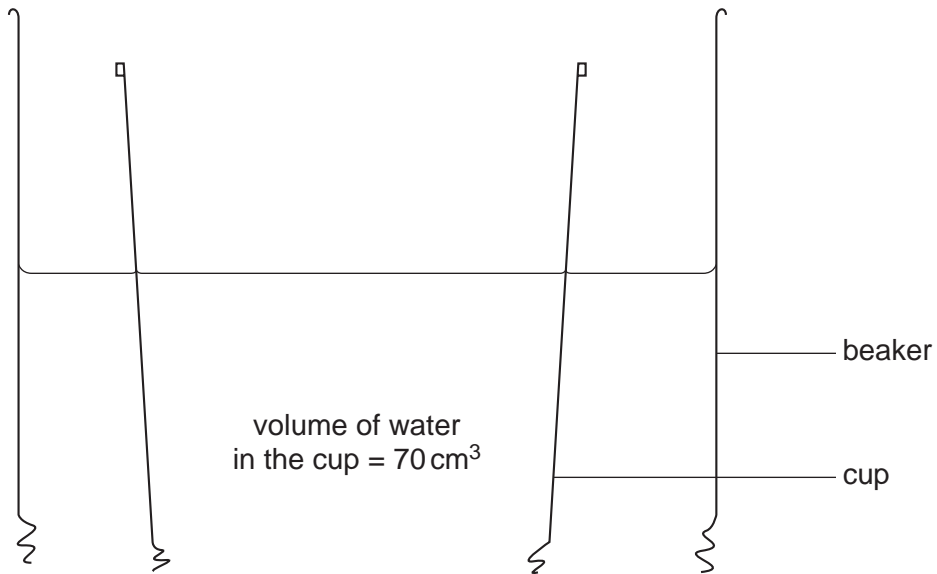
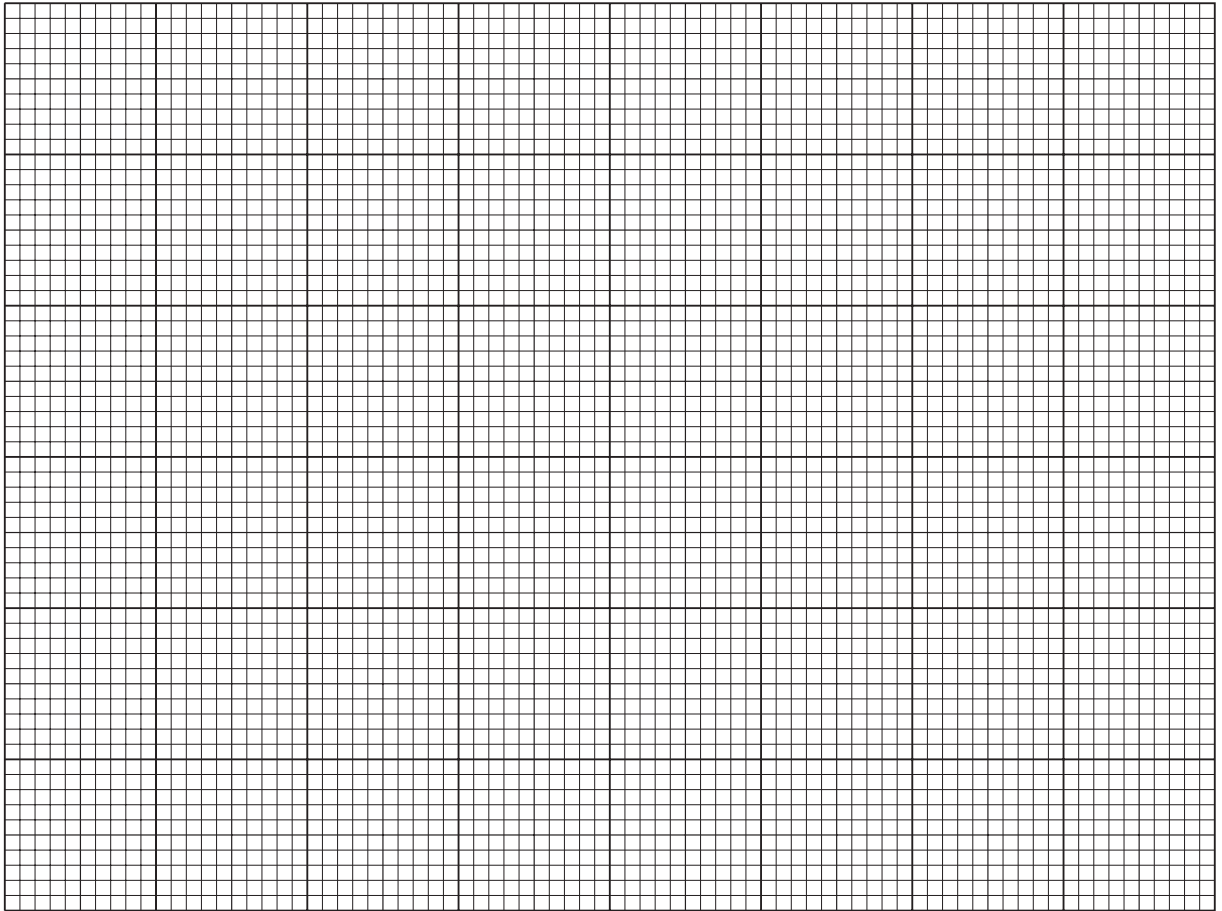

Fig. 6.4

- (d) (i) Plot a graph of **h** (vertical axis) against the volume of water in the cup. Draw the best straight line through your points and extend it to cut the horizontal axis.



[3]

- (ii) Read off from your graph the volume when **h** = 0.

volume =cm³ [1]

- (iii) What will happen to the cup when **h** = 0?

.....[1]

- (e) Did the experiment prove the statement that the student read? Explain your answer.

.....
[1]

