



UNIVERSITY OF CAMBRIDGE INTERNATIONAL EXAMINATIONS
International General Certificate of Secondary Education

CO-ORDINATED SCIENCES

0654/12

Paper 1 Multiple Choice

May/June 2011

45 minutes

Additional Materials: Multiple Choice Answer Sheet
Soft clean eraser
Soft pencil (type B or HB is recommended)



READ THESE INSTRUCTIONS FIRST

Write in soft pencil.

Do not use staples, paper clips, highlighters, glue or correction fluid.

Write your name, Centre number and candidate number on the Answer Sheet in the spaces provided unless this has been done for you.

There are **forty** questions on this paper. Answer **all** questions. For each question there are four possible answers **A, B, C** and **D**.

Choose the **one** you consider correct and record your choice in **soft pencil** on the separate Answer Sheet.

Read the instructions on the Answer Sheet very carefully.

Each correct answer will score one mark. A mark will not be deducted for a wrong answer.

Any rough working should be done in this booklet.

A copy of the Periodic Table is printed on page 16.

This document consists of **15** printed pages and **1** blank page.



1 Which process releases energy in all living things?

- A breathing
- B digestion
- C muscle contraction
- D respiration

2 The diagram shows four vertebrate animals.

P

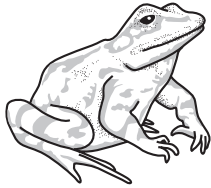

Q

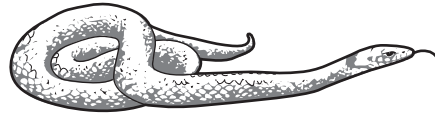

R

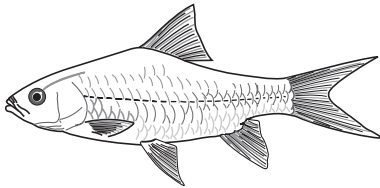

S

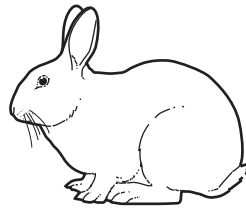

Which animals have lungs?

- A P, Q and R B Q, R and S C R, S and P D S, P and Q

3 Which molecule carries energy into a cell and which is a process that uses this energy?

	molecule	process
A	glucose	growth
B	iron	movement
C	protein	digestion
D	starch	storage

- 4 The diagram shows a root hair cell.

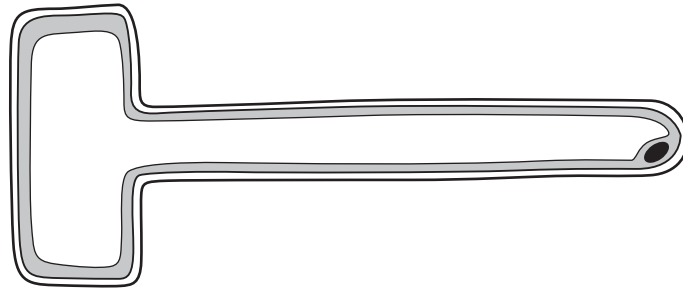

What shows that it is a plant cell?

- A It has a large surface area.
 - B It has a large vacuole.
 - C It has no cell membrane.
 - D It has no cell wall.
- 5 What happens shortly after eating a large amount of sugar?
- A More insulin is secreted by the pancreas.
 - B More urea is made in the liver.
 - C More urine is excreted by the kidneys.
 - D More water is removed from the blood.

6 The diagram shows part of the alimentary canal.

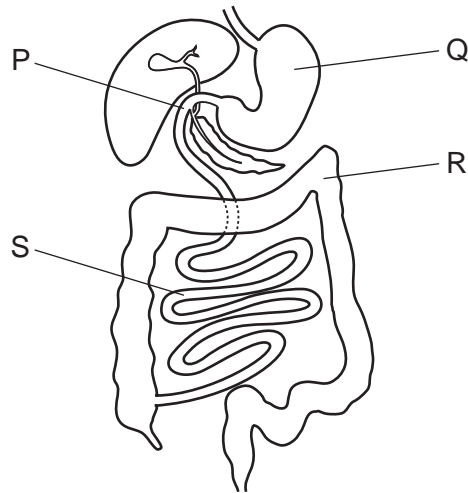

Where is bile added and where is acid released?

	addition of bile	release of acid
A	P	Q
B	Q	R
C	R	S
D	S	P

7 Tests were carried out on a clear liquid. The table shows the results.

test	result
biuret	purple colour
ethanol	white colour
iodine	brown colour

What did the clear liquid contain?

	fat	protein	starch	
A	✓	✓	✓	key ✓ = yes x = no
B	✓	✓	x	
C	✓	x	✓	
D	x	✓	✓	

8 The diagram shows a section through the heart.

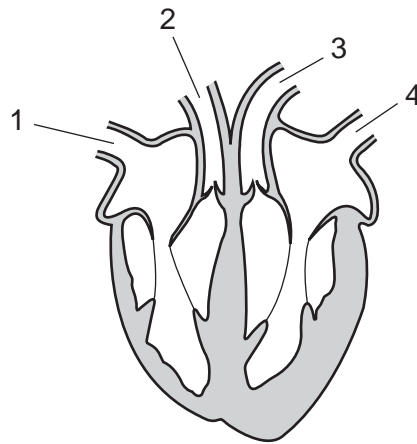

Which two blood vessels are arteries?

- A** 1 and 2 **B** 2 and 3 **C** 3 and 4 **D** 4 and 1

9 What is an ecosystem?

- A** a community and its habitat
B a group of organisms and their predators
C all the organisms in a food chain
D where an organism lives

10 The diagram shows a short food chain.

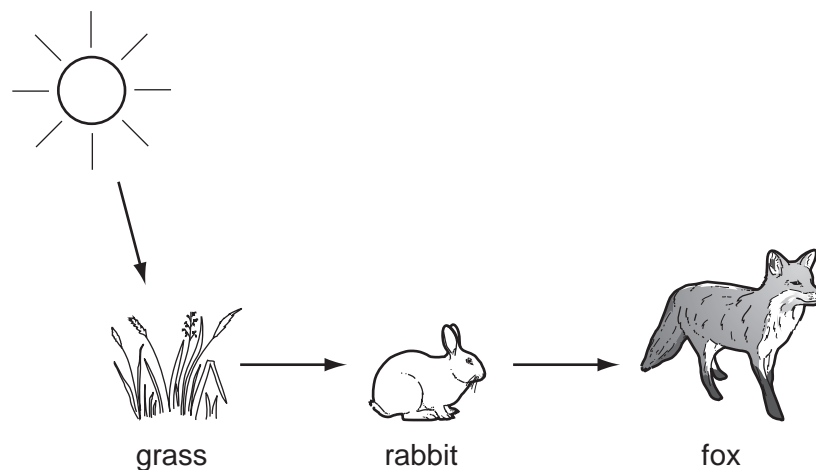

In the food chain, what is the importance of the rabbit?

- A** It absorbs carbon dioxide.
B It absorbs the Sun's energy.
C It passes on energy from plants.
D It releases oxygen.

11 Which is an example of cloning?

- A pollinating flowers by insects
- B producing offspring by sexual intercourse
- C producing plants by tissue culture
- D seeds forming in an ovary

12 Why is seed dispersal important?

- A It causes the development of a fruit.
- B It makes seeds more fertile.
- C It prevents asexual reproduction.
- D It reduces competition between seedlings.

13 What passes from a mother to a fetus in her uterus?

- A blood platelets
- B mineral ions
- C plasma
- D red blood cells

14 Which trends in physical properties are correct for the alkali metals down Group I?

	hardness	melting point
A	decreases	decreases
B	decreases	increases
C	increases	decreases
D	increases	increases

15 What is made when amino acids join together in a large chain?

- A cellulose
- B glucose
- C protein
- D starch

16 The graph shows the changes in temperature when a substance is cooled.

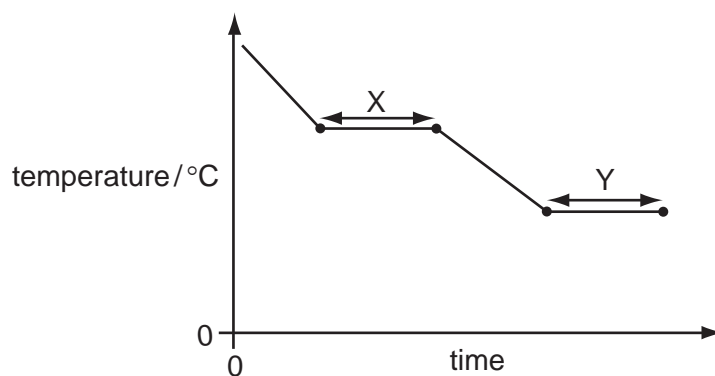

Which describes the processes occurring at X and Y?

	X	Y
A	boiling	melting
B	condensing	freezing
C	freezing	condensing
D	melting	boiling

17 Some properties of three substances are shown.

substance	melting point /°C	boiling point /°C	electrical conductivity when molten
W	801	1413	good
X	-111	-78	poor
Y	1610	2230	poor

What are the structures of W, X and Y?

	giant covalent structure	giant ionic structure	molecular structure
A	W	Y	X
B	X	W	Y
C	Y	W	X
D	Y	X	W

18 Large hydrocarbons can be1..... to make smaller, more useful molecules.

Small hydrocarbon molecules can be2..... to make long molecules.

Which words correctly complete gaps 1 and 2?

	1	2
A	cracked	distilled
B	cracked	polymerised
C	distilled	polymerised
D	distilled	cracked

19 Electrolysis of sodium chloride is used to obtain chlorine.

In what form is sodium chloride electrolysed and at which electrode is the chlorine obtained?

	form of sodium chloride	electrode at which chlorine is obtained
A	in aqueous solution	anode
B	in aqueous solution	cathode
C	solid	anode
D	solid	cathode

20 How is carbon (coke) used in the extraction of iron from iron oxide?

- A** as an anode
- B** as a cathode
- C** as an oxidising agent
- D** as a reducing agent

21 Sodium hydroxide solution is added to hydrochloric acid.

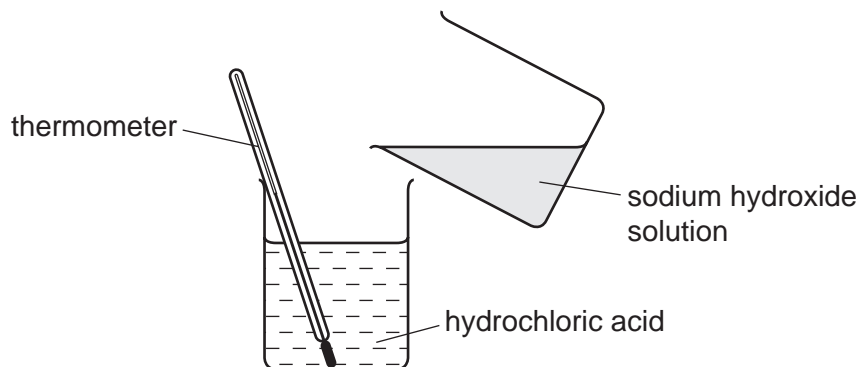

Which shows how the pH and temperature change as the reaction takes place?

	pH	temperature
A	decrease	decrease
B	decrease	increase
C	increase	decrease
D	increase	increase

22 Which statements about a positive test for a nitrate ion are correct?

- 1 Aluminium is used.
- 2 The nitrate ion is reduced to ammonia.
- 3 Ammonia turns damp litmus paper red.

A 1, 2 and 3 **B** 1 and 2 only **C** 1 and 3 only **D** 2 and 3 only

23 A solution is tested by adding acidified silver nitrate solution.

Which ion causes the white precipitate to form?

- A** chloride ions, Cl^-
B copper ions, Cu^{2+}
C hydroxide ions, OH^-
D sodium ions, Na^+

24 Which statement about methane is **not** correct?

- A Methane burns in air to form carbon dioxide and water.
- B Methane can be obtained from the decay of waste material.
- C Methane is a fossil fuel.
- D When methane burns, an endothermic reaction takes place.

25 The diagram shows part of the Periodic Table.

Which element has atoms containing three electrons in the outer shell?

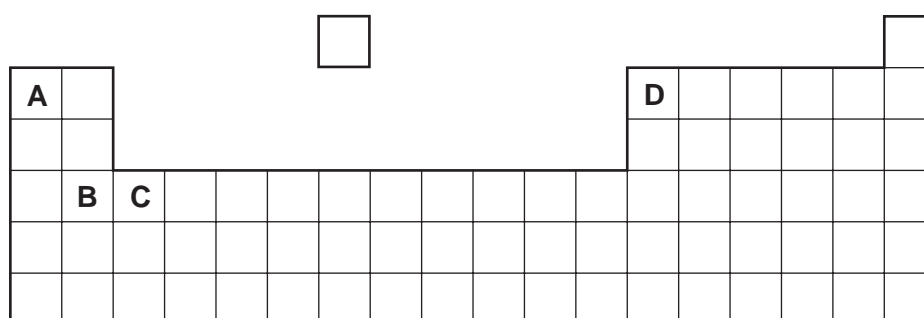

26 Aspirin can be used to relieve headaches.

Which terms correctly describe aspirin?

	analgesic	chemotherapy agent	drug
A	✓	✓	x
B	✓	x	✓
C	x	✓	x
D	x	x	✓

key

✓ = yes

x = no

27 Which is **not** a colloid?

- A cellulose
- B milk
- C paint
- D smoke

- 28 One side of a cube stands on the ground.

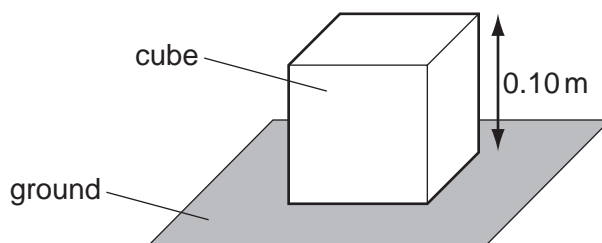

The cube weighs 200 N and its sides are 0.10 m long.

How much pressure does the cube exert on the ground?

- A 2.0 Pa B 20 Pa C 2000 Pa D 20 000 Pa
- 29 A student needs to find the density of a large cubic block of wood.
- Which two pieces of apparatus should she use?
- A balance and metre rule
 B balance and thermometer
 C measuring cylinder and metre rule
 D measuring cylinder and thermometer
- 30 In an experiment, a student measures the time taken for an object to fall to the ground. He carries out the experiment ten times. The table shows his results.

time/s	26.4	26.8	26.4	24.4	24.0	26.8	25.4	23.4	26.4	24.0
--------	------	------	------	------	------	------	------	------	------	------

Which value should the student use?

- A 24.0 s B 25.4 s C 26.4 s D 26.8 s
- 31 Which group contains only secondary colours of light?
- A cyan, green, magenta
 B cyan, green, yellow
 C green, magenta, yellow
 D yellow, cyan, magenta

32 Two cars have different masses and different speeds as shown.

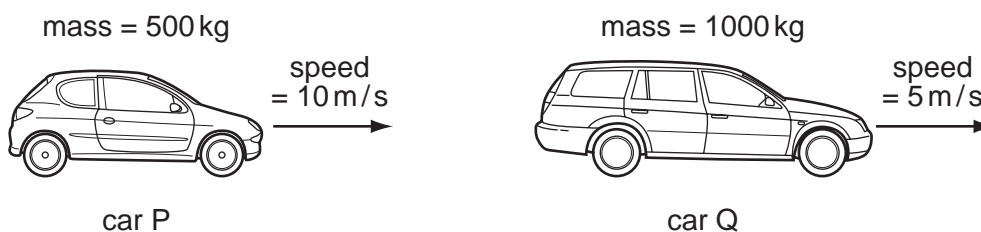

How do the momentum and the kinetic energy of the two cars compare?

	momentum	kinetic energy
A	P greater than Q	P less than Q
B	P equal to Q	P greater than Q
C	P equal to Q	P equal to Q
D	P less than Q	P equal to Q

33 A satellite orbits the Earth.

Is the satellite in a gravitational field and is the satellite in a magnetic field?

	a gravitational field	a magnetic field
A	✓	✓
B	✓	✗
C	✗	✓
D	✗	✗

key

✓ = in field

✗ = not in field

34 What is meant by the current in a wire?

- A** the charge flowing through the wire per second
- B** the energy the wire can transfer elsewhere per second
- C** the power the wire can produce per second
- D** the work the wire does per second

35 An electronic circuit is used as a temperature detector.



The current in the detector is small. The detector operates a component that allows it to control a larger current in a heater.

Which component is suitable?

- A a diode
- B a dynamo
- C a reed relay
- D a transformer

36 Microphones and earphones are both used with audio equipment.

Which energy change takes place in a microphone and which takes place in an earphone?

	microphone	earphone
A	electrical to sound	electrical to sound
B	electrical to sound	sound to electrical
C	sound to electrical	electrical to sound
D	sound to electrical	sound to electrical

37 Electrical energy from a power station is used a long distance away from it.

Which row shows the type of current needed and the device used for efficient transmission?

	type of current	device
A	alternating	dynamo
B	alternating	transformer
C	direct	dynamo
D	direct	transformer

38 Which process is used in a nuclear power station and which nuclear change happens in this process?

	process used	nuclear change
A	fission	heavy nuclei split
B	fission	light nuclei join together
C	fusion	heavy nuclei split
D	fusion	light nuclei join together

39 Which row describes the properties of beta radiation?

	electromagnetic	ionising	
A	✓	✓	key ✓ = yes x = no
B	✓	x	
C	x	✓	
D	x	x	

40 The diagram shows the basic structure of a cathode-ray tube in an oscilloscope.

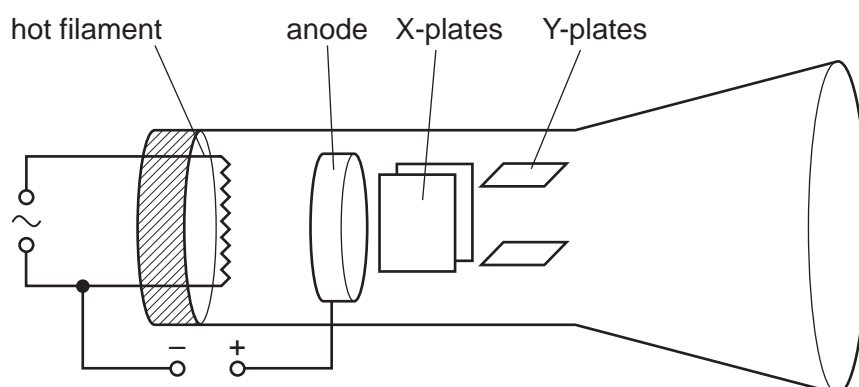

From which component do the cathode rays start?

- A** the anode
- B** the hot filament
- C** the X-plates
- D** the Y-plates

