



**Cambridge International Examinations**  
Cambridge International General Certificate of Secondary Education

CANDIDATE  
NAME

--

CENTRE  
NUMBER

--	--	--	--	--

CANDIDATE  
NUMBER

--	--	--	--

\* 4 2 3 5 1 5 9 8 2 7 \*



**CO-ORDINATED SCIENCES**

**0654/62**

Paper 6 Alternative to Practical

**October/November 2015**

**1 hour**

Candidates answer on the Question Paper.

No Additional Materials are required.

**READ THESE INSTRUCTIONS FIRST**

Write your Centre number, candidate number and name on all the work you hand in.

Write in dark blue or black pen.

You may use an HB pencil for any diagrams or graphs.

Do not use staples, paper clips, glue or correction fluid.

**DO NOT WRITE IN ANY BARCODES.**

Answer **all** questions.

Electronic calculators may be used.

You may lose marks if you do not show your working or if you do not use appropriate units.

At the end of the examination, fasten all your work securely together.

The number of marks is given in brackets [ ] at the end of each question or part question.

This document consists of **19** printed pages and **1** blank page.

1 A student carries out some tests to determine the food groups present in rice and milk.

(a) (i) Complete the second row of Table 1.1 to show which food group each test is able to identify. [3]

(b) Milk gives a positive result with Benedict's reagent and biuret reagent.

Rice gives a positive result with biuret reagent and iodine solution.

Complete Table 1.1 to show the colours observed for these positive results. [3]

**Table 1.1**

reagent	Benedict's	biuret	iodine
food group identified			
colour with milk at end of test			orange
colour with rice at end of test	blue		

(c) (i) Describe how you could carry out the test for the presence of fats in a food.

.....  
 .....  
 ....., [2]

(ii) State what is observed if the result of the test in (c)(i) is positive.

..... [1]

(iii) Suggest why the test you have described in (c)(i) may be difficult to carry out on the milk.

....., [1]

2 The teacher gives a student samples of a calcium salt. The student will carry out four experiments.

(a) Fig. 2.1 shows the apparatus for **experiment 1**. Read the instructions for the experiment which are shown below the diagram.

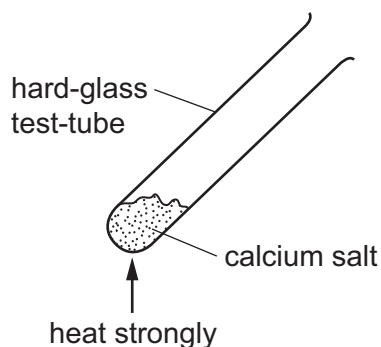

**Fig. 2.1**

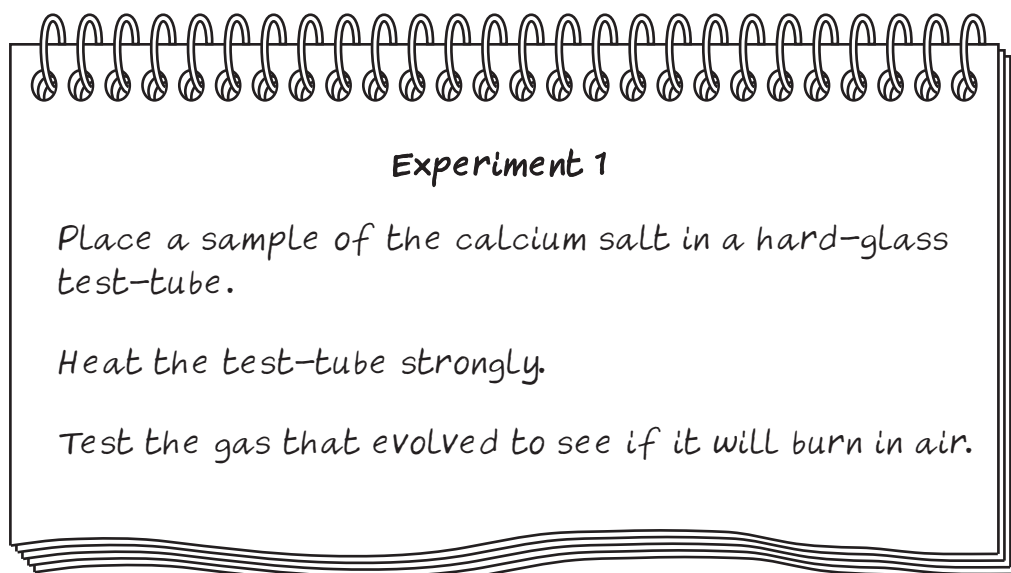

Describe how the student can find out if the gas will burn in air.

test .....

result ..... [1]

- (b) Fig. 2.2 shows the apparatus for **experiment 2**. Read the instructions for the experiment which are shown below in the diagram.

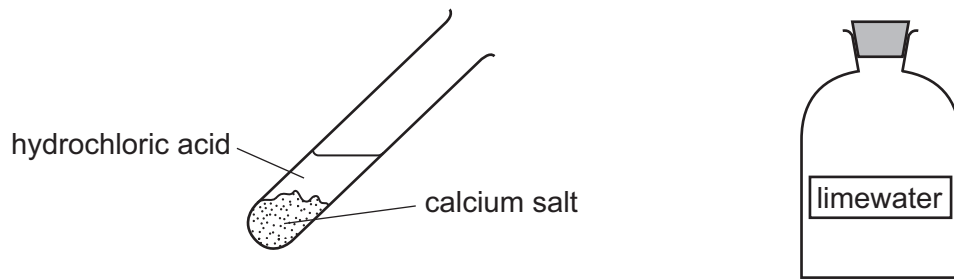

**Fig. 2.2**

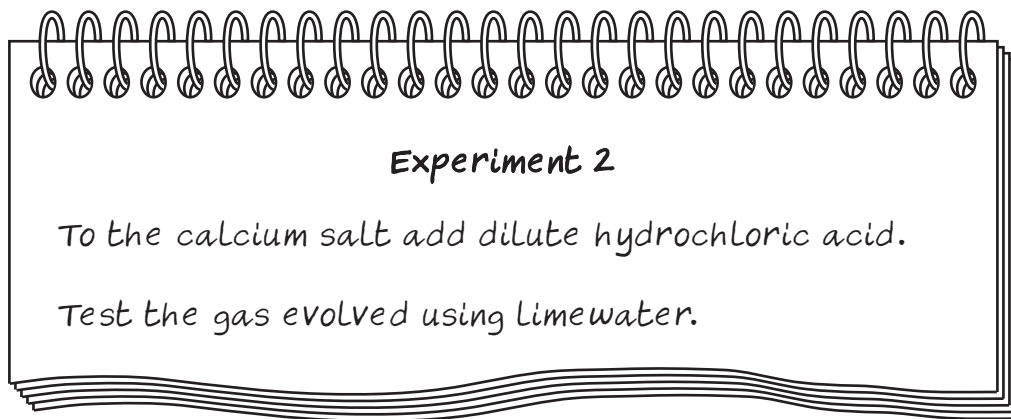

- (i) Draw a diagram to show how the student can test the gas coming out of the test-tube using limewater. State the positive result for this test.

result .....

[2]

- (ii) Name the gas that gives the positive result in (b)(i).

.....

[1]

- (c) **Experiment 2** gives a positive result with limewater.

Name this calcium salt.

.....

[1]

- (d) Fig. 2.3 shows the apparatus for **experiment 3**. Read the instructions for the experiment which are shown below the diagram.

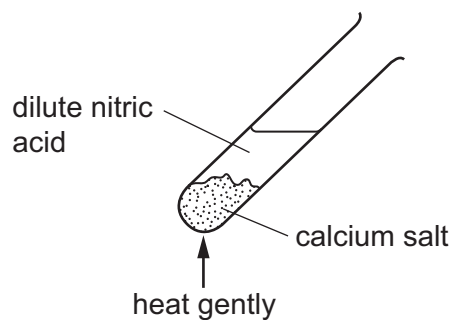

**Fig. 2.3**

**Experiment 3**

*Add dilute nitric acid to a fresh sample of the calcium salt.*

*Warm the test-tube gently.*

*Test the gas that evolves to see if it is acidic.*

- (i) Describe how the student can test if the gas is acidic.

test .....

result ..... [2]

- (ii) Explain why the test-tube must be warmed gently rather than heated strongly.

..... [1]

- (e) The teacher gives the student two acids of the same concentration, acid Y and acid Z.

Fig. 2.4 shows the apparatus for **experiment 4**. Read the instructions for the experiment which are shown below the diagram.

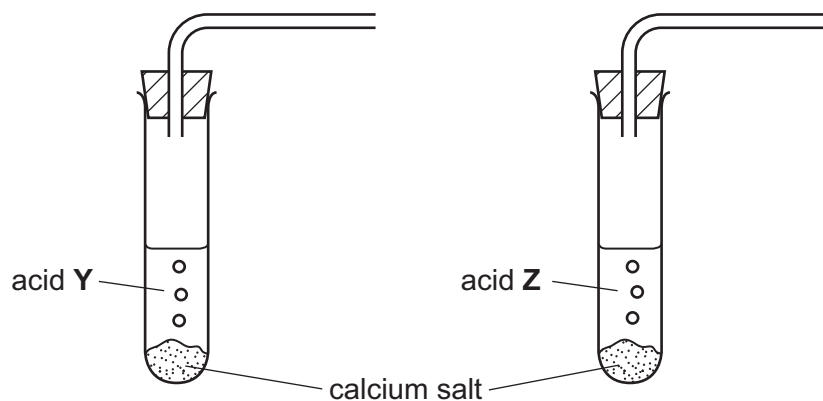

**Fig. 2.4**

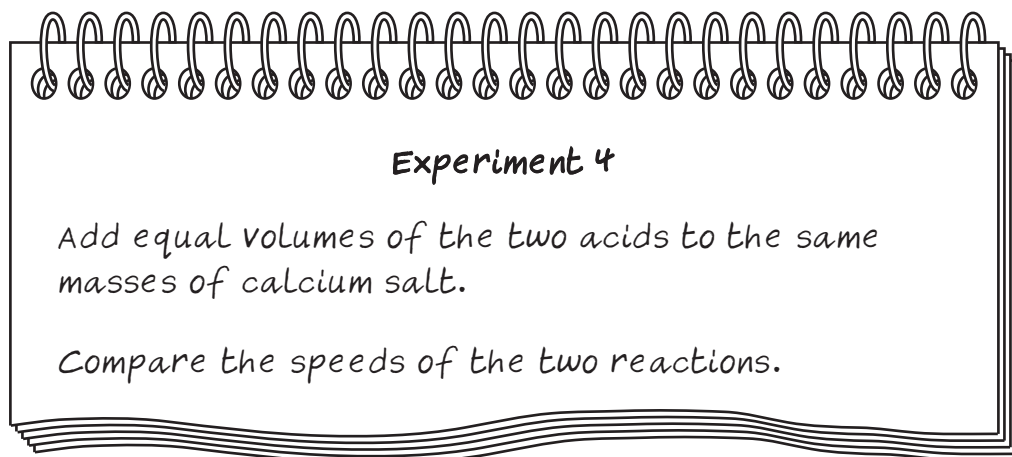

Suggest how the student can use the gas produced by each reaction to compare the speeds of the reactions. You may draw a diagram to illustrate your answer.

.....

.....

.....

[2]

3 A student is investigating different components in a circuit.

He sets up the apparatus shown in Fig. 3.1. He then carries out an experiment to measure the resistance of the power supply.

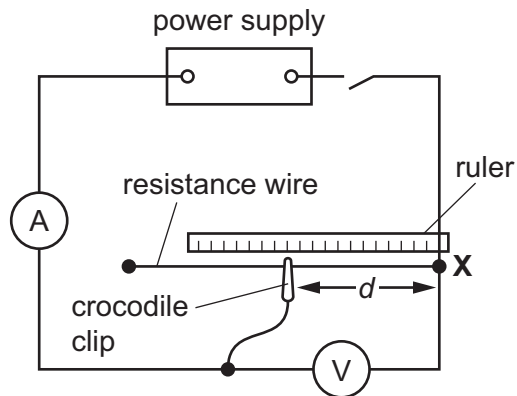

Fig. 3.1

### Procedure

- Connect the crocodile clip to the resistance wire at a distance  $d = 15$  cm from point **X**.
- Close the switch.
- Read the ammeter and voltmeter and then immediately open the switch.
- Record the readings in Table 3.1.
- Repeat this procedure for the other distances from point **X** shown in Table 3.1.

- (a) Fig. 3.2 shows the ammeter and voltmeter readings for the distances  $d = 25$  and  $d = 40$  cm. Read the meters to a suitable number of decimal places and record the readings in Table 3.1.

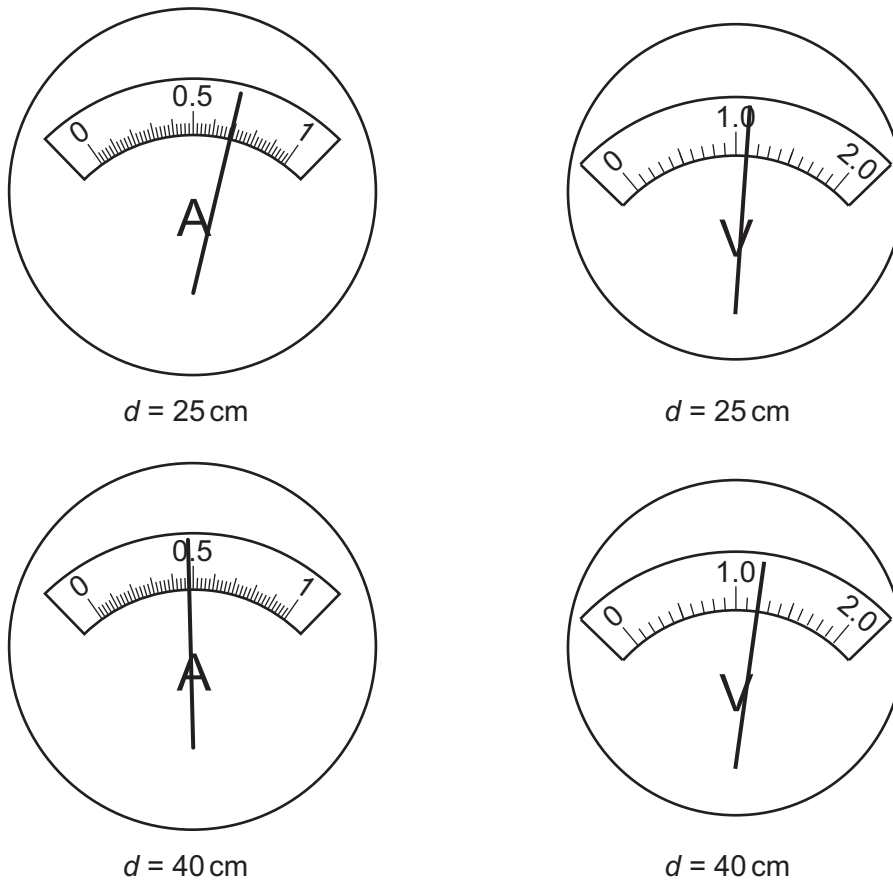

Fig. 3.2

[3]

Table 3.1

distance $d$ /cm	current $I$ /amps	potential difference $V$ /volts
15	0.97	0.9
20	0.81	1.0
25		
40		
60	0.34	1.3
100	0.22	1.4



- (b) (i) On the grid provided, plot a graph of  $V$  against  $I$ . Draw the best-fit straight line. [2]

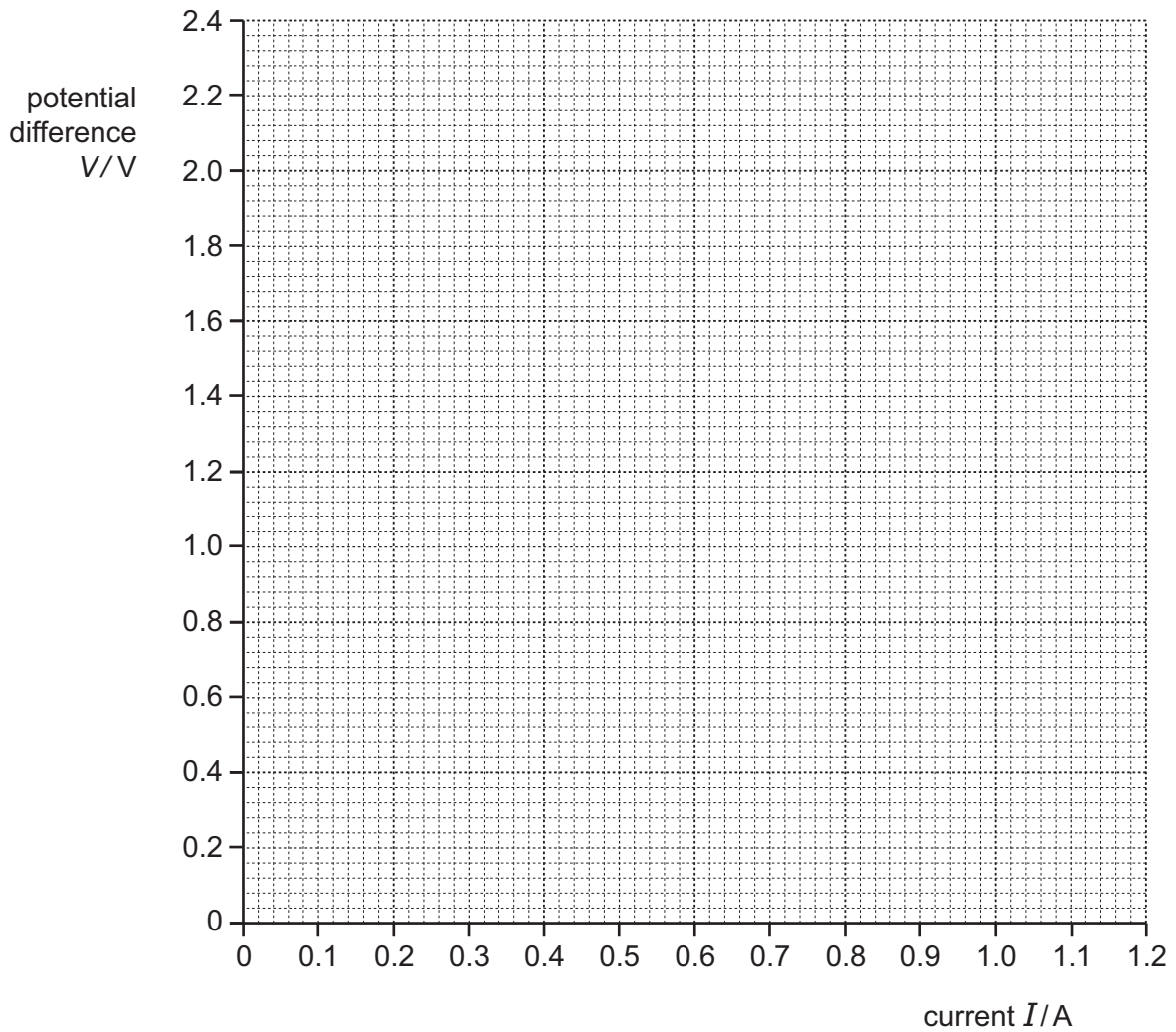

- (ii) Calculate the gradient of your line. Show all working and indicate on your graph the values you chose to enable the gradient to be calculated.

gradient = ..... [2]

- (iii) The positive value of the gradient of the graph is equal to the resistance of the power supply. Write the positive value of the gradient to an appropriate number of significant figures.

resistance of power supply = .....  $\Omega$  [1]

(c) (i) Suggest a reason why distance  $d$  must not be less than 15 cm.

.....  
..... [1]

(ii) Suggest a reason why the student must open the switch immediately after taking each reading.

.....  
..... [1]

- 4 In a flower, ripe stigmas produce a fluid containing sugar. The sugar stimulates pollen grains that land on a stigma to grow *pollen tubes*. These pollen tubes allow the nucleus from the pollen to travel to the egg (ovum) in the ovary so that fertilisation can take place.

Pollen tubes can be observed using a light microscope. Fig. 4.1 shows a photograph of some of these pollen tubes.

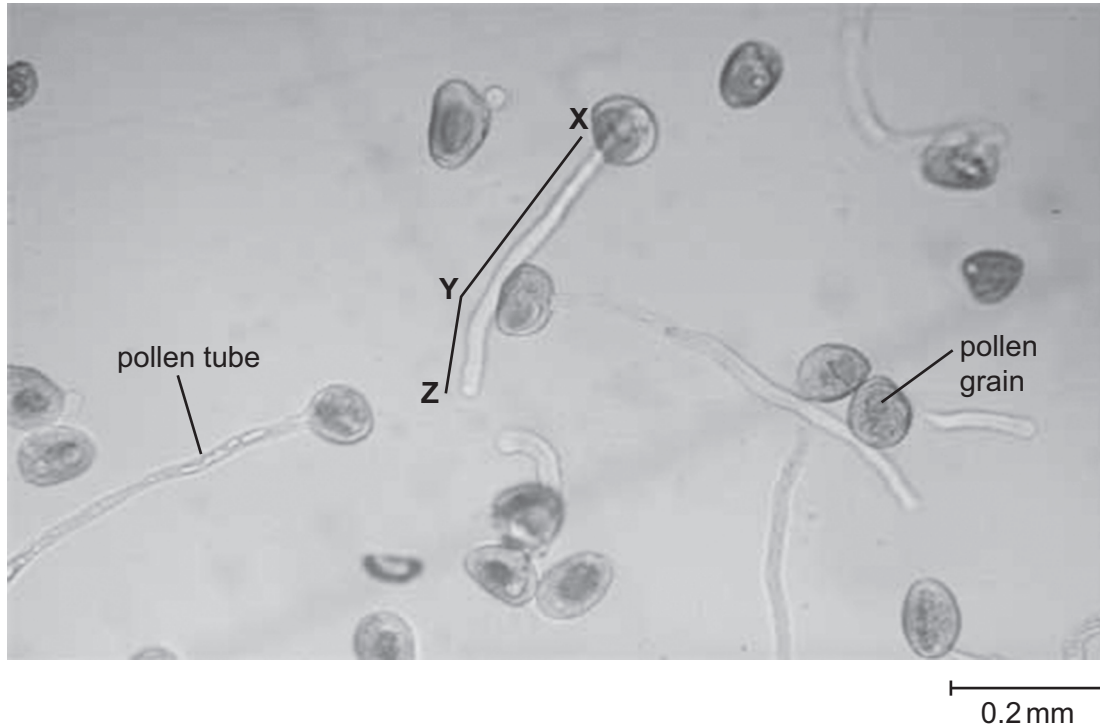

**Fig. 4.1**

- (a) Measure and record the total length of the pollen tube as indicated by the line **X-Y-Z** on Fig. 4.1. With the help of the scale bar on the side of Fig. 4.1, calculate the actual length of the pollen tube.

Show your working.

Total length of pollen tube on image (**X-Y-Z**) = ..... mm [2]

Actual length of **X-Y-Z** = ..... mm [2]

(b) A student investigates the effect of different strength sugar solutions on the growth of pollen tubes.

- He places a drop of sugar solution on a microscope slide and adds pollen grains to it.
- He leaves the slide in a warm place for an hour and then looks at the slide using the microscope.
- He counts the number of pollen grains that he can see and then calculates the percentage that have pollen tubes.

His results are shown in Table 4.1.

**Table 4.1**

concentration of sugar solution ( $\text{mol}/\text{dm}^3$ )	% of pollen grains with pollen tubes			
	experiment 1	experiment 2	experiment 3	average
0	0	0	0	0
0.25	36	28	32	
0.50	72	68	76	
0.75	49	41	45	
1	10	7	13	

Complete the last column of Table 4.1.

[1]

- (c) (i) Use Table 4.1 to plot on the grid below a graph of average percentage of pollen grains with tubes (vertical axis) against sugar concentration. Draw a best-fit curve.

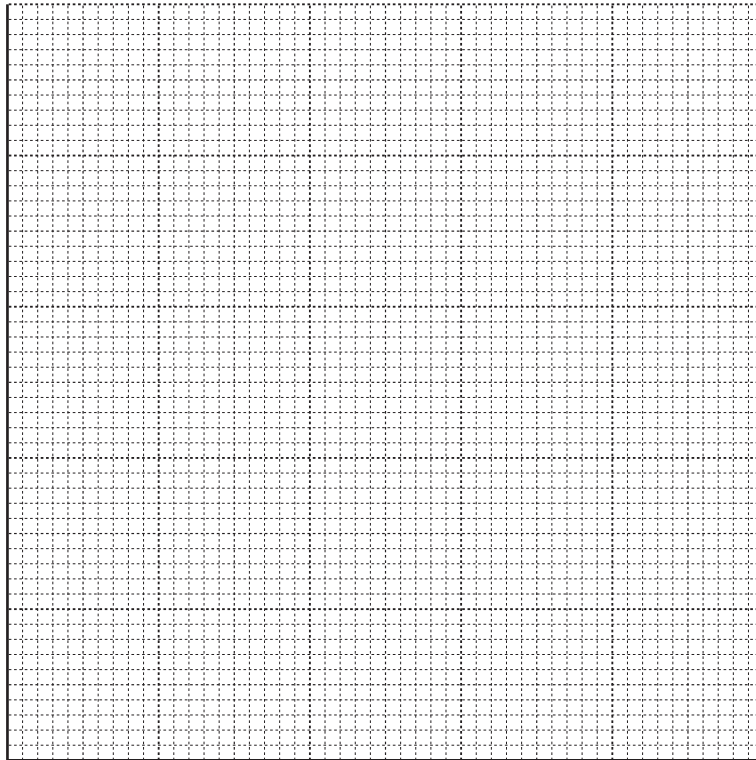

[4]

- (ii) Use your graph to suggest the best concentration of sugar for pollen tube growth.

..... [1]

- 5 A group of students investigate some of the chemical and physical properties of iron, Fe.

### Chemical properties

One student places iron nails into test-tubes, as shown in Fig. 5.1, and leaves them for one week.

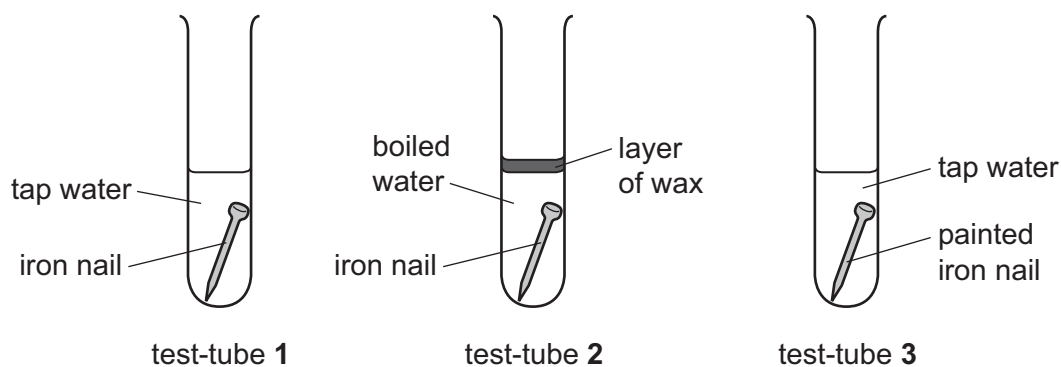

Fig. 5.1

- (a) (i) State how the appearance of the nail in test-tube 1 changes after one week.

.....  
 ....., [1]

- (ii) Describe the appearance of the nail in test-tube 2 after one week.

.....  
 ....., [1]

- (iii) Explain why there is no change to the nail in test-tube 3 after one week.

.....  
 ....., [1]

- (b) Another student adds hydrochloric acid to iron filings. He notices that bubbles of gas are formed.

- (i) He carries out a test that confirms the gas is hydrogen.

Describe the test he uses and the observation.

test .....

observation .....

....., [1]

- (ii) The iron dissolves, making a light green solution. The student thinks that the green solution contains iron(II) ions.

Explain how he proves the presence of iron(II) ions in the green solution.

.....  
....., [1]

- (iii) The student takes some of the green solution and adds a colourless oxidising agent. The mixture changes colour.

The teacher says that the iron(II) ions have been changed to iron(III) ions.

State the colour of the mixture containing iron(III) ions.

..... [1]

- (iv) Explain how the student proves the presence of iron(III) ions in this mixture.

.....  
....., [1]





- 6 A student has samples of three different liquids, **A**, **B** and **C**.

He carries out an experiment to compare the densities of these liquids. The apparatus he uses is shown in Fig. 6.1.

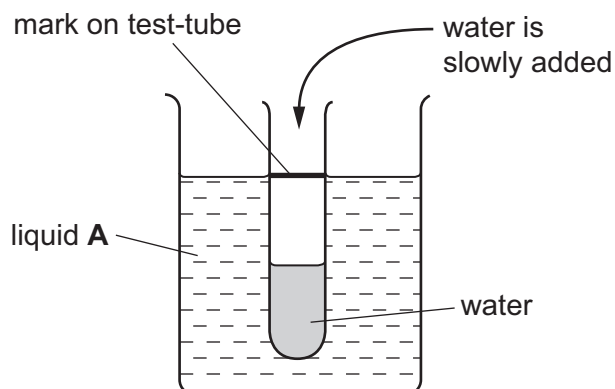

Fig. 6.1

### Method

- He makes a mark on a test-tube.
- He holds the test-tube upright in the beaker and slowly adds water to it, drop by drop, until it floats in the beaker of liquid **A** and the mark on the test-tube is level with the surface of liquid **A**.
- He pours the water from the test-tube into a measuring cylinder and records the volume in Table 6.1.
- He repeats the experiment using liquids **B** and **C**.

- (a) Name the piece of apparatus that the student could use to add water, drop by drop, to the test-tube in Fig. 6.1.

..... [1]

- (b) The liquid which requires the greatest volume of water in the test-tube is the most dense. Fig. 6.2 shows the volume of water contained in each test-tube when it floats in liquids **A**, **B** and **C**.

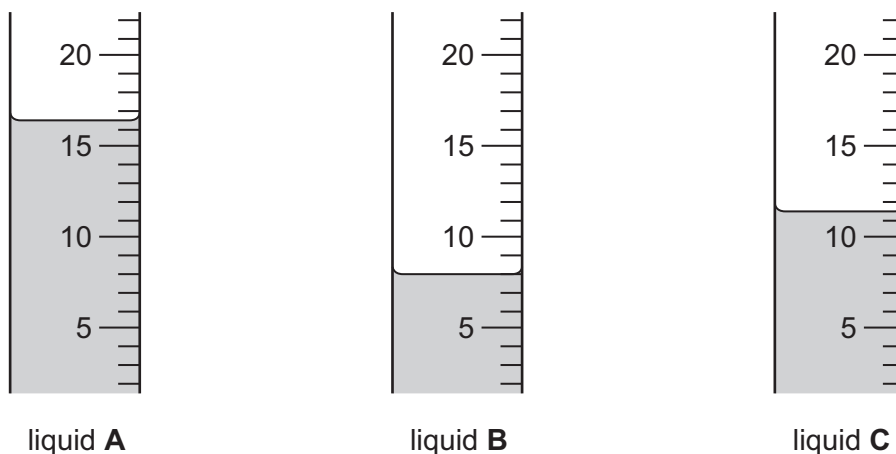

**Fig. 6.2**

- (i) Record, in Table 6.1, each volume of water to the nearest  $0.5 \text{ cm}^3$ .

**Table 6.1**

	liquid <b>A</b>	liquid <b>B</b>	liquid <b>C</b>
volume of water / $\text{cm}^3$			

[3]

- (ii) Use the results from Table 6.1 to place the liquids **A**, **B**, and **C** in order of density.

most dense .....

.....

least dense .....

[1]

- (c) The teacher tells the student that one of the three liquids is water.

Suggest **one** chemical test and **one** physical test that the student can use to identify the water.

chemical test

.....

physical test

.....

[2]

- (d) Another student uses two pieces of apparatus to measure two properties of the sample of liquid **A** which he can use to calculate the density of liquid **A**.

- (i) Suggest the names of two pieces of apparatus that he uses and the property measured by each by completing the sentences.

The student uses a ..... to measure the .....  
of the sample of liquid **A**.

The student uses a ..... to measure the .....  
of the sample of liquid **A**. [2]

- (ii) State how the student uses the two measurements to calculate the density of liquid **A**.

.....

....., [1]

**BLANK PAGE**

---

Permission to reproduce items where third-party owned material protected by copyright is included has been sought and cleared where possible. Every reasonable effort has been made by the publisher (UCLES) to trace copyright holders, but if any items requiring clearance have unwittingly been included, the publisher will be pleased to make amends at the earliest possible opportunity.

To avoid the issue of disclosure of answer-related information to candidates, all copyright acknowledgements are reproduced online in the Cambridge International Examinations Copyright Acknowledgements Booklet. This is produced for each series of examinations and is freely available to download at [www.cie.org.uk](http://www.cie.org.uk) after the live examination series.

Cambridge International Examinations is part of the Cambridge Assessment Group. Cambridge Assessment is the brand name of University of Cambridge Local Examinations Syndicate (UCLES), which is itself a department of the University of Cambridge.